

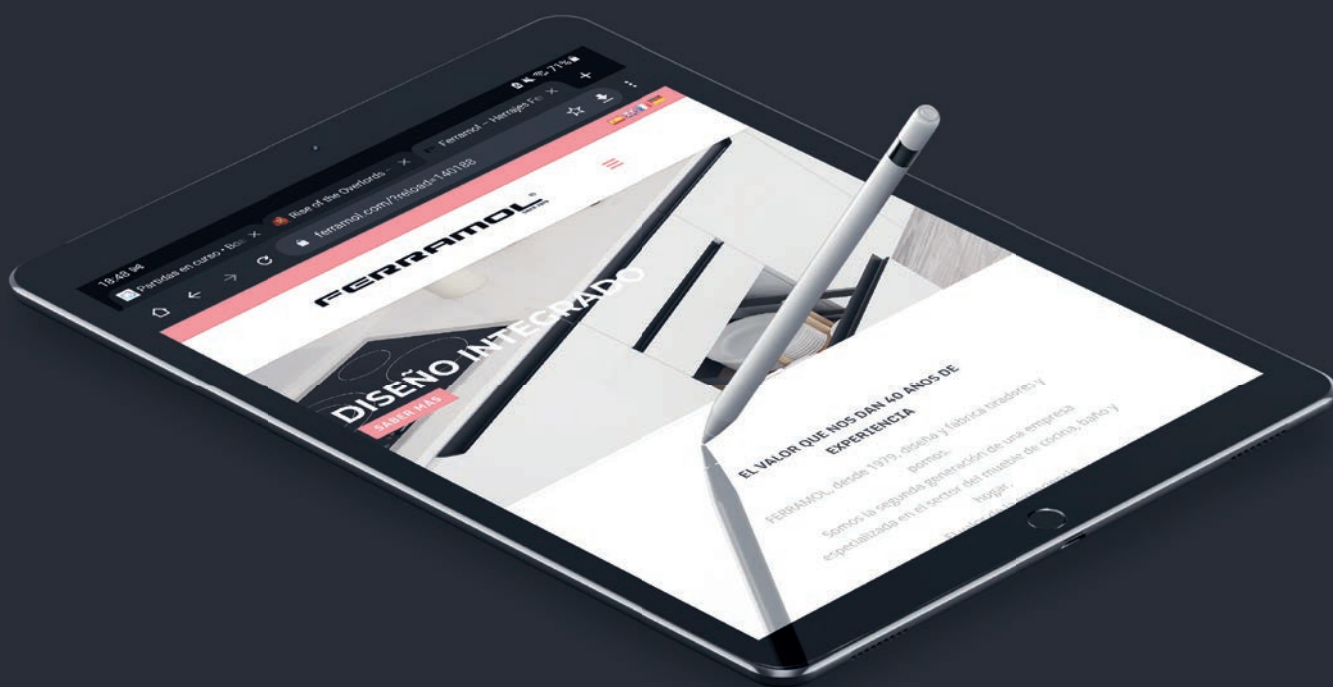

FRE GADE ROS

FERRAMOL [®]
SINCE 1979



ÍN DICE

Ref.	Pag.
392	6
393	6
394	6
403	6
237	10
357	10
358	10
359	10
360	14
361	14
362	14
113	18
114	20
14	24
02	26
67	30
196	34

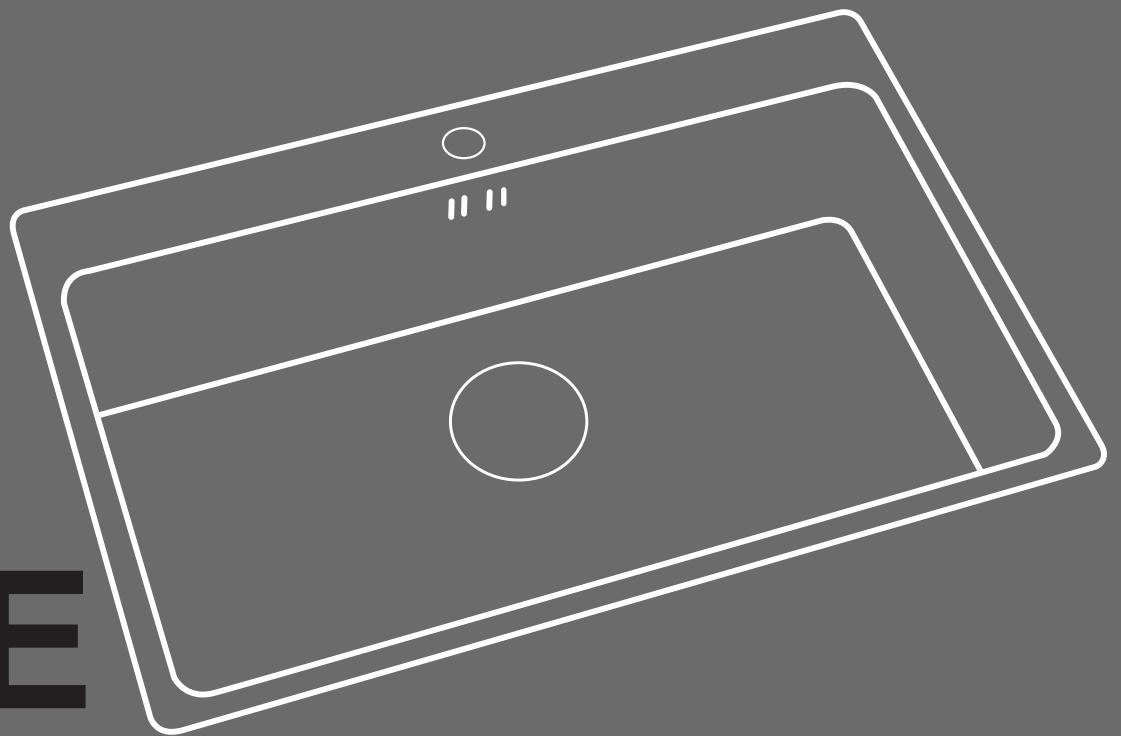

5

FRE

GADEROS

SINK

PUITS

SPÜLBECKEN

6





8

CUBETA METÁLICA • ACERO PULIDO





Fr. 392/393/394/403
Material: Acero pulido



5 uds./box

CARACTERÍSTICAS TÉCNICAS • TECHNICAL CHARACTERISTICS • CARACTÉRISTIQUES TECHNIQUES

FREGADERO/SINK/PUITS
FR 392 · 40 X 40 CMS.

DESCRIPCION:
40x40 sobre encimera

MATERIAL:
AISI 304 - 18/10
Acero Pulido/Polished steel/Acier poli

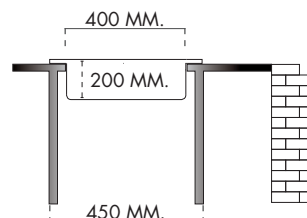
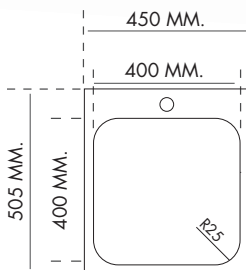

FREGADERO/SINK/PUITS
FR 393 · 40 X 45 CMS.

DESCRIPCION:
40x45 sobre encimera

MATERIAL:
AISI 304 - 18/10
Acero Pulido/Polished steel/Acier poli

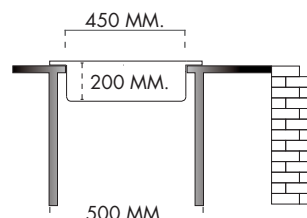
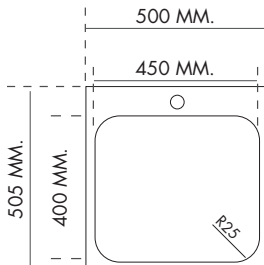

FREGADERO/SINK/PUITS
FR 394 · 40 X 50 CMS.

DESCRIPCION:
40x45 sobre encimera

MATERIAL:
AISI 304 - 18/10
Acero Pulido/Polished steel/Acier poli

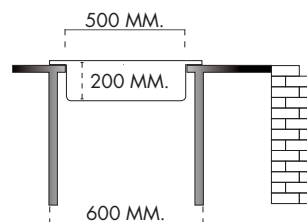
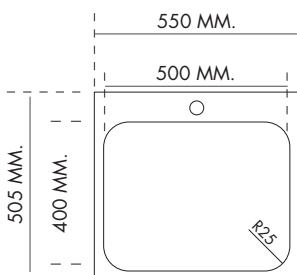

FREGADERO/SINK/PUITS
FR 403 · 40 X 71 CMS.

DESCRIPCION:
40x71 sobre encimera

MATERIAL:
AISI 304 - 18/10
Acero Pulido/Polished steel/Acier poli

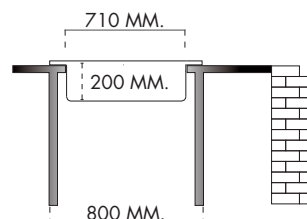
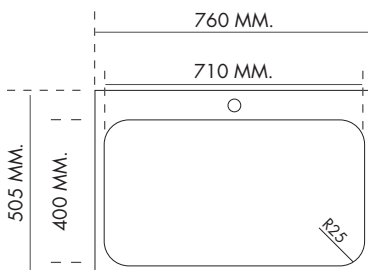



10



Fr. 237/357/358/359

Material: Acero pulido



Fr. 237

5 uds./box

Fr. 357-358-359

10 uds./box

CARACTERÍSTICAS TÉCNICAS • TECHNICAL CHARACTERISTICS • CARACTÉRISTIQUES TECHNIQUES

FREGADERO/SINK/PUITS
FR 357 · 40 X 40 CMS.

DESCRIPCION:

40x40 sobre encimera/bajo encimera

MATERIAL:

AISI 304 - 18/10

Acero Pulido/Polished steel/Acier poli

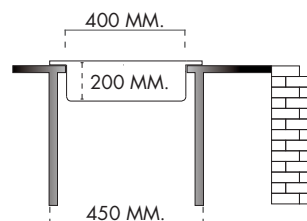
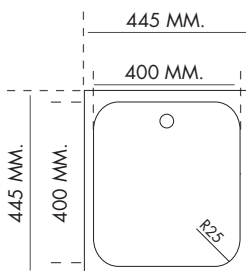

FREGADERO/SINK/PUITS
FR 358 · 40 X 45 CMS.

DESCRIPCION:

40x45 sobre encimera/bajo encimera

MATERIAL:

AISI 304 - 18/10

Acero Pulido/Polished steel/Acier poli

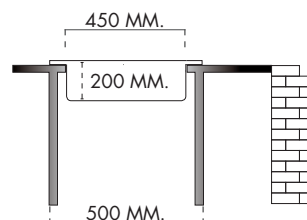
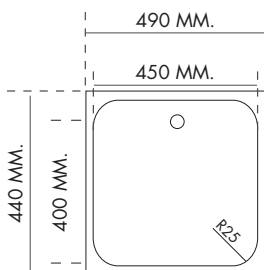

FREGADERO/SINK/PUITS
FR 359 · 40 X 50 CMS.

DESCRIPCION:

40x45 sobre encimera/bajo encimera

MATERIAL:

AISI 304 - 18/10

Acero Pulido/Polished steel/Acier poli

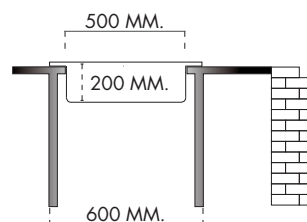
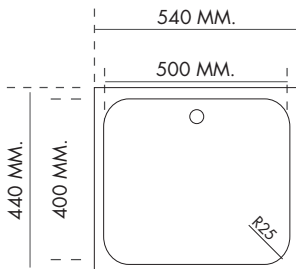

FREGADERO/SINK/PUITS
FR 237 · 40 X 71 CMS.

DESCRIPCION:

40x71 sobre encimera/bajo encimera

MATERIAL:

AISI 304 - 18/10

Acero Pulido/Polished steel/Acier poli

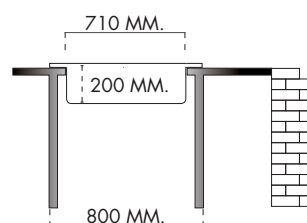
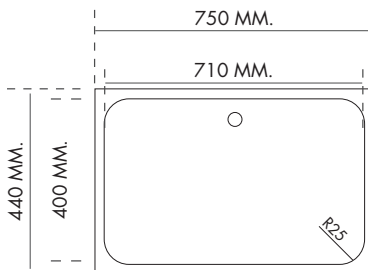

12

CUBETA METÁLICA • ORO PULIDO



**NUEVOS ACABADOS
NEW FINISHES
NOUVELLES FINITIONS
NEUE AUSFÜHRUNGEN**



Oro _ Gold _ Or _ Gold



Negro _ Black _ Noir _ Schwarz

Fr. 358/359

Material: Acero pulido



Fr. 358-359

10 uds./box

CARACTERÍSTICAS TÉCNICAS • TECHNICAL CHARACTERISTICS • CARACTÉRISTIQUES TECHNIQUES

FREGADERO/SINK/PUITS
FR 358 · 40 X 45 CMS.

DESCRIPCION:

40x45 sobre encimera/bajo encimera

MATERIAL:

AISI 304 - 18/10

Acero Pulido/Polished steel/Acier poli

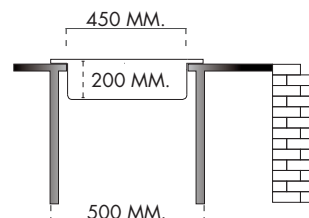
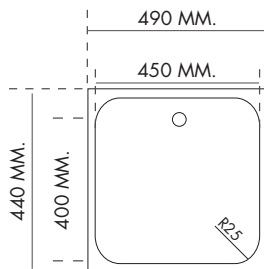

FREGADERO/SINK/PUITS
FR 359 · 40 X 50 CMS.

DESCRIPCION:

40x45 sobre encimera/bajo encimera

MATERIAL:

AISI 304 - 18/10

Acero Pulido/Polished steel/Acier poli

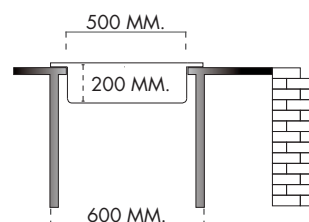
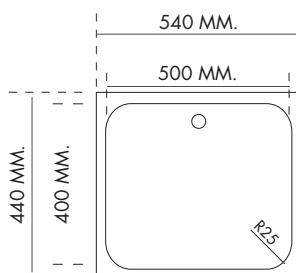







CUBETA METÁLICA • ACERO PULIDO



Fr. 360/361/362
Material: Acero pulido



10 uds./box

CARACTERÍSTICAS TÉCNICAS • TECHNICAL CHARACTERISTICS • CARACTÉRISTIQUES TECHNIQUES

FREGADERO/SINK/PUITS
FR 360 · 40 X 40 CMS.

DESCRIPCION:
40x40 bajo encimera

MATERIAL:
AISI 304 - 18/10
Acero Pulido/Polished steel/Acier poli

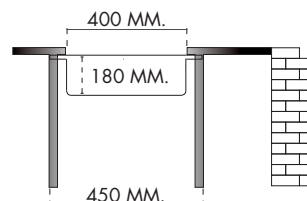
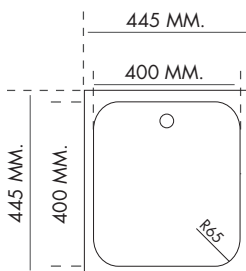

FREGADERO/SINK/PUITS
FR 361 · 40 X 45 CMS.

DESCRIPCION:
40x45 bajo encimera

MATERIAL:
AISI 304 - 18/10
Acero Pulido/Polished steel/Acier poli

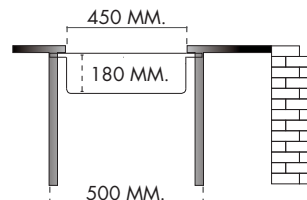
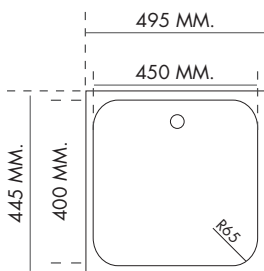

FREGADERO/SINK/PUITS
FR 362 · 40 X 50 CMS.

DESCRIPCION:
40x50 bajo encimera

MATERIAL:
AISI 304 - 18/10
Acero Pulido/Polished steel/Acier poli

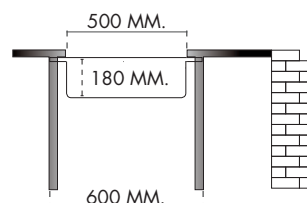
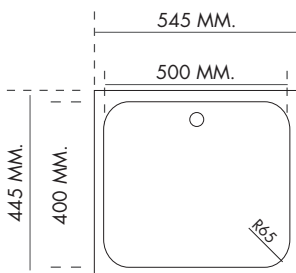



18



Fr. 113
Material: Acero pulido

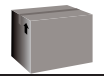

10 uds./box



CUBETA METÁLICA • ACERO PULIDO

CARACTERÍSTICAS TÉCNICAS • TECHNICAL CHARACTERISTICS • CARACTÉRISTIQUES TECHNIQUES

FR 113 · 50 X 79 CMS.

DESCRIPCION:
50x79 sobre encimera

MATERIAL:
AISI 304 - 18/10 Acero Pulido
Polished steel/Acier poli

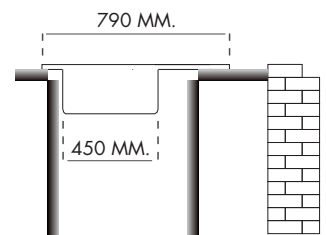
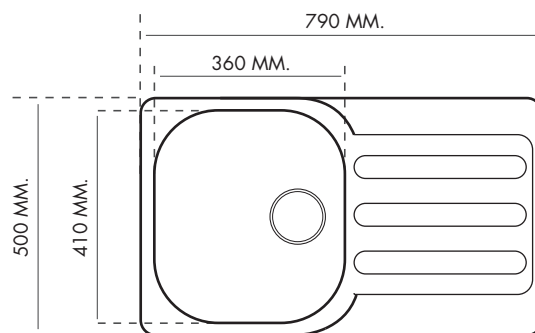





CUBETA METÁLICA • ACERO PULIDO

22





Fr. 114
Material: Acero pulido



10 uds./box

CARACTERÍSTICAS TÉCNICAS • TECHNICAL CHARACTERISTICS • CARACTÉRISTIQUES TECHNIQUES

FR 114 · 50 X 79 CMS.

DESCRIPCION:
50x79 sobre encimera

MATERIAL:
AISI 304 - 18/10 Acero Pulido
Polished steel/Acier poli

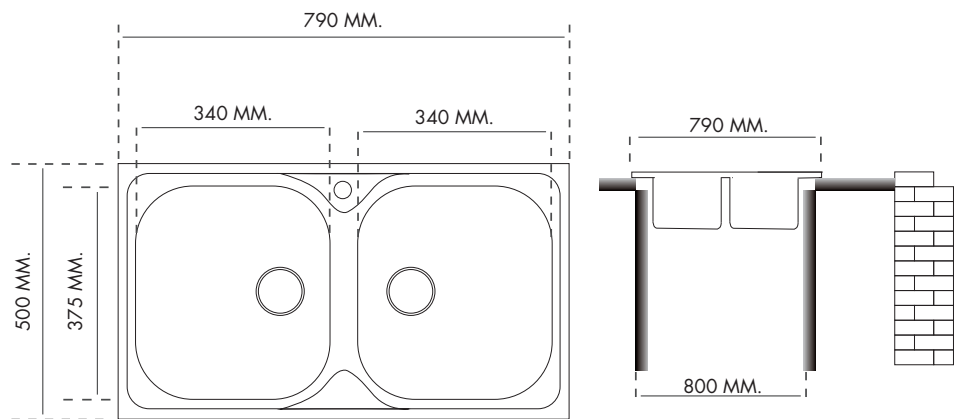

CUBETA METÁLICA • ACERO PULIDO

24





25

Fr. 14
Material: Acero pulido



10 uds./box

CARAC. TÉCNICAS • TECHNICAL CHARACTERISTICS • CARACTÉRISTIQUES TECHNIQUES

FR 14 · 50 X 50 CMS.

DESCRIPCION:
40x40 sobre encimera

MATERIAL:
AISI 304 - 18/10 Acero Pulido
Polished steel/Acier poli

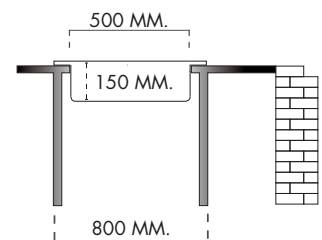
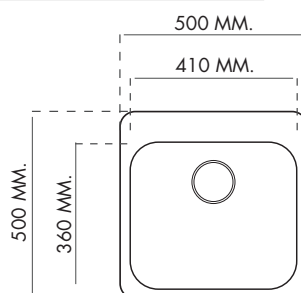







CUBETA METÁLICA • ACERO PULIDO



Fr. 02
Material: Acero pulido



10 uds./box

CARACTERÍSTICAS TÉCNICAS • TECHNICAL CHARACTERISTICS • CARACTÉRISTIQUES TECHNIQUES

FR 02 · 51 CMS.

DESCRIPCION:
40x40 sobre encimera

MATERIAL:
AISI 304 - 18/10 Acero Pulido
Polished steel/Acier poli

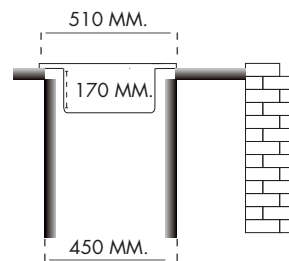
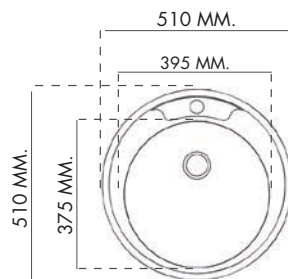







CUBETA METÁLICA • ACERO PULIDO

32



Fr. 67
Material: Acero pulido



10 uds./box

CARACTERÍSTICAS TÉCNICAS • TECHNICAL CHARACTERISTICS • CARACTÉRISTIQUES TECHNIQUES

FR 67 · 51 X 785 CMS.

DESCRIPCION:
51x78 sobre encimera

MATERIAL:
AISI 304 - 18/10 Acero Pulido
Polished steel/Acier poli

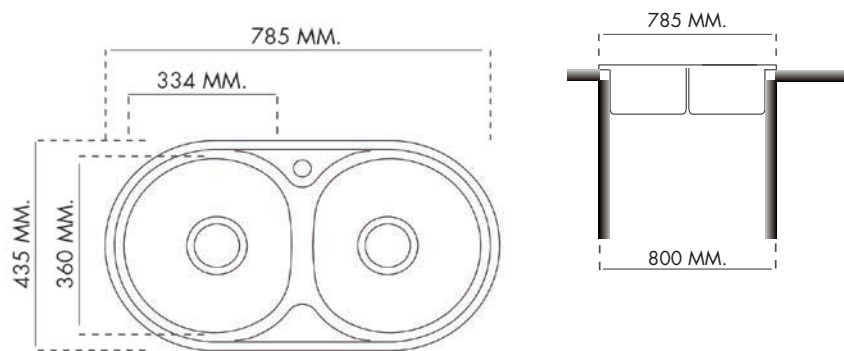





CUBETA METÁLICA • ACERO PULIDO

36



**Fr. 196**

Material: Acero pulido



10 uds./box

CARACTERÍSTICAS TÉCNICAS • TECHNICAL CHARACTERISTICS • CARACTÉRISTIQUES TECHNIQUES

FR 196 · 51 X 78 CMS.

DESCRIPCION:

51x78 sobre encimera

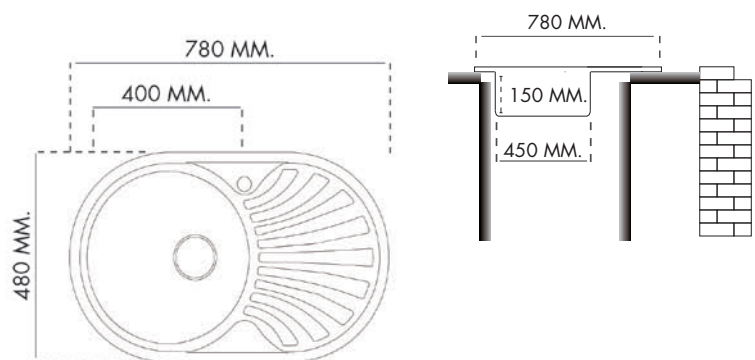
MATERIAL:AISI 304 - 18/10 Acero Pulido
Polished steel/Acier poli

Reservados todos los derechos.

No se permite la reproducción, total o parcial, de ninguna parte de este catálogo y publicación en internet o sobre cualquier otro medio sin la autorización escrita del fabricante

Todos los productos, marcas comerciales y las fotografías reproducidas en este catálogo están sujetos a todas las leyes de propiedad intelectual existentes. Los colores de este catálogo deben ser considerados orientativos.

2025 IMPRESO EN CE

All rights reserved.

Reproduction of any part of this catalogue and publication on the internet or on any other medium is not permitted without manufacturer, written permission.

All products, trade-marks and photographs reproduced in this catalogue are subject to all existing intellectual property laws.

The colors of this catalogue should be considered merely illustrative.

2025 PRINTED IN CE

Tous droits réservés.

Aucune partie de ce catalogue ne peut être reproduite, en totalité ou en partie, et publiée sur Internet ou sur tout autre support. sans l'autorisation écrite de fabricant
Tous les produits, marques commerciales et photographies reproduits dans ce catalogue soumis à toutes les lois existantes sur la propriété intellectuelle.

Les couleurs figurant dans ce catalogue doivent être considérées comme un guide.

2025 IMPRIMÉ EN CE

FERRAMOL®
SINCE 1979

FERRAMOL

SINCE 1979

C/ CABAÑAL, 71
46687 ALBALAT DE LA RIBERA (VALENCIA • SPAIN)

TEL. + 34 962 490 388

 +34 664 377 997

info@ferramol.com
export@ferramol.com

www.ferramol.com

SHOWROOM • MADRID

DYAMPA

C/ Pablo Picasso, 3 - 28830 San Fernando de Henares • (MADRID)

 +34 664 377 997

SHOWROOM • GERMANY

Industriestraße 58 • 32289 RÖDINGHAUSEN • (GERMANY)

 +49 1724008340

martina@ferramol.com

