

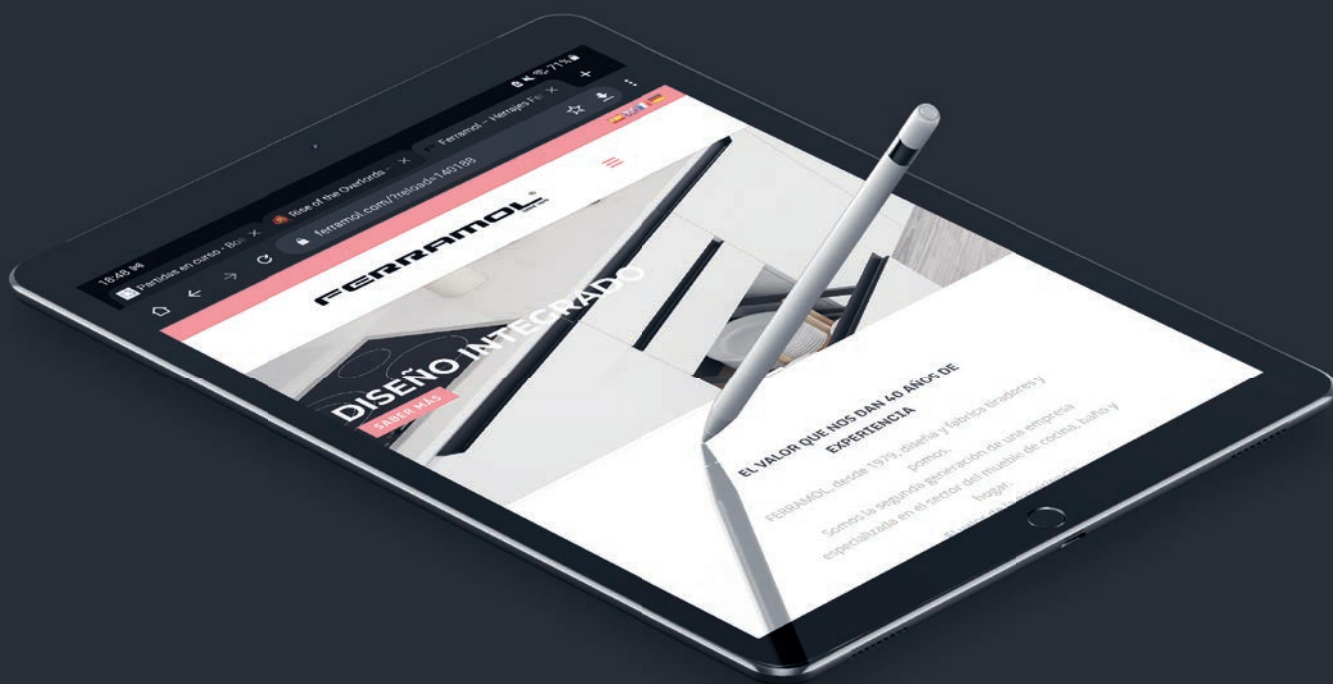

.new  
collection

2024 • 2025

**FERRAMOL**<sup>®</sup>  
SINCE 1979



**FERRAMOL**®  
SINCE 1979

## EVERYTHING STARTS HERE

Creating on paper is incredibly inspiring as it opens up a realm of limitless possibilities. This marks the inception of our journey. We sketch, refine, and progress until we define the ultimate design, aimed at assisting the consumer in making a more personal choice.

## AQUI EMPIEZA TODO

Dibujar en un papel resulta muy inspirador porque todo es posible.

Aquí empieza nuestro trabajo. Trazar, corregir, avanzar hasta definir el diseño final que ayude al consumidor a conseguir una elección más personal.



## TOUT COMMENCE ICI

Dessiner sur papier est très inspirant car tout est possible. Ici commence notre travail. Esquisser, corriger, progresser jusqu'à définir le design final qui aide le consommateur à faire un choix plus personnel.

## HIER BEGINNT ALLES

Das Zeichnen auf Papier ist sehr inspirierend, weil alles möglich ist. Hier beginnt unsere Arbeit. Skizzieren, korrigieren, voranschreiten, bis das endgültige Design definiert ist, das dem Verbraucher hilft, eine persönlichere Wahl zu treffen.





## FERRAMOL®

Somos una empresa familiar con más de 30 años de experiencia, especializada en el diseño y fabricación de herrajes para el sector de muebles de cocina, baño y en general. En la actualidad, la segunda generación está modernizando tanto los sistemas de producción como el diseño de productos, así como la gestión, con el objetivo de ofrecer a nuestros clientes productos innovadores que reinventan las formas clásicas.

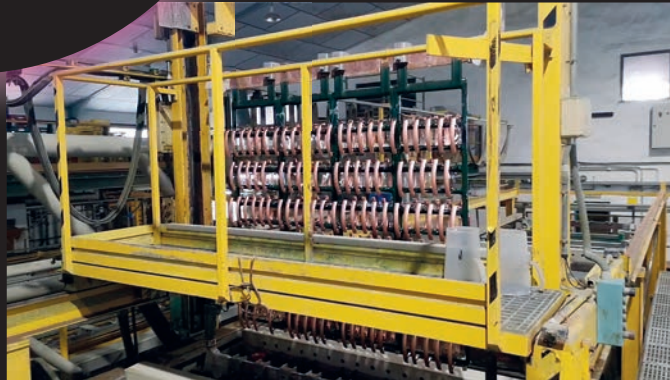

## FERRAMOL®

*Stands as a distinguished family enterprise, boasting over three decades of expertise in crafting cutting-edge fittings for the kitchen, bathroom, and broader furniture sector. Embarking on the journey of modernization, the second generation spearheads the transformation of production and design systems, alongside innovative management strategies. Our commitment is to cater to customers with groundbreaking products that breathe new life into classic forms.*

## INNOVATION AND PRODUCTION

*In the realm of innovation and production, we uphold stringent environmental standards. Ferramol® products are meticulously crafted from top-tier materials such as Zamak, Nickel, Brass, Aluminium, Plastic, Inox, and more. Positioned as a stalwart in both national and international markets, Ferramol® caters to wholesalers and furniture manufacturers alike. Our brand proudly showcases its creations at renowned international fairs, symbolizing a commitment to excellence and forward-thinking design.*



## INNOVACION Y PRODUCCIÓN

Los procesos de producción son exigentes en cuanto al respeto al medio ambiente. Para la fabricación de los productos Ferramol®, utilizamos exclusivamente materiales de alta calidad como el Zamak, Níquel, Latón, Aluminio, Plástico, Inox, entre otros.

Ferramol® está presente en los principales mercados nacionales e internacionales para mayoristas y fabricantes de muebles. Asimismo, la marca Ferramol® exhibe sus creaciones en las ferias internacionales más importantes.

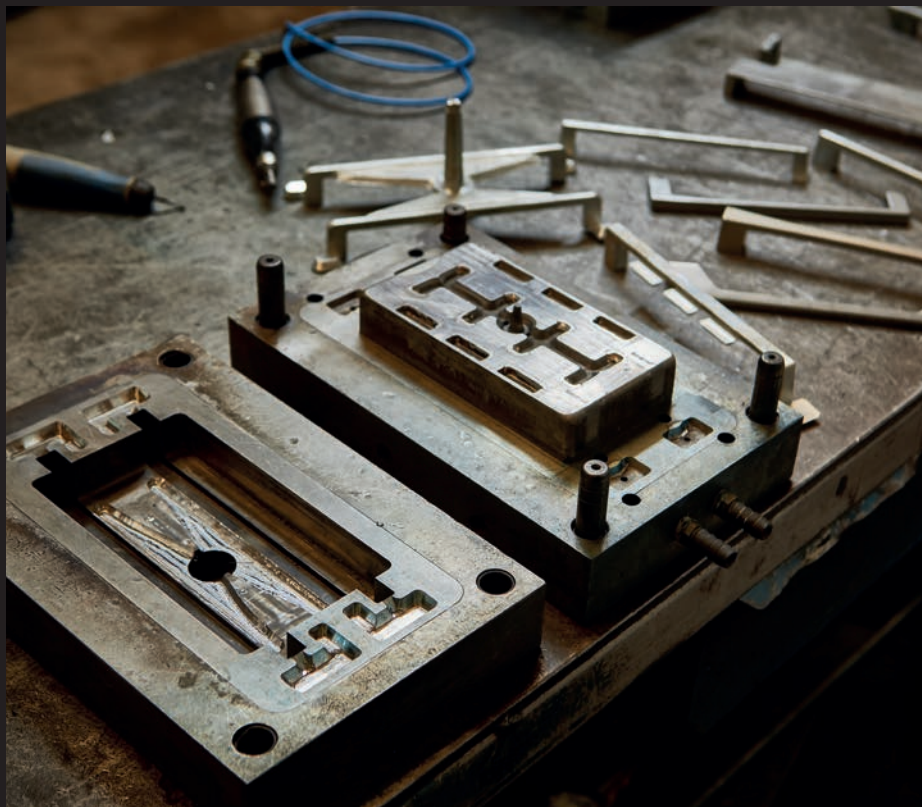

### FERRAMOL®

Wir sind ein Familienunternehmen mit mehr als 30 Jahren Erfahrung, das sich auf die Entwicklung und Herstellung von Beschlägen für die Küchen- und Badezimmermöbelbranche sowie im Allgemeinen spezialisiert hat. Heute modernisiert die zweite Generation sowohl die Produktions- als auch die Produktdesignsysteme sowie das Management, um unseren Kunden mit innovativen Produkten zu begegnen, die klassische Formen neu interpretieren.

### INNOVATION UND PRODUKTION

Die Produktionsprozesse stellen hohe Ansprüche an die Umwelt. Bei der Herstellung von Ferramol® Produkten verwenden wir ausschließlich hochwertige Materialien wie Zamak, Nickel, Messing, Aluminium, Kunststoff, Inox usw. Ferramol® ist in den wichtigsten nationalen und internationalen Märkten für Großhändler und Möbelhersteller präsent. Ebenso präsentiert die Marke Ferramol® ihre Kreationen auf den wichtigsten internationalen Messen.

### FERRAMOL®

*Nous sommes une entreprise familiale forte de plus de 30 ans d'expérience, spécialisée dans la conception et la fabrication de quincaillerie pour le secteur de la cuisine, de la salle de bains et du mobilier en général. Aujourd'hui, la deuxième génération modernise à la fois les systèmes de production et de conception des produits, ainsi que la gestion, afin de répondre à nos clients avec des produits innovants qui réinventent les formes classiques.*

### L'INNOVATION ET LA PRODUCTION

*Les processus de production exigent le respect de l'environnement. Pour la fabrication des produits Ferramol®, nous utilisons exclusivement des matériaux de haute qualité tels que le Zamak, le Nickel, le Laiton, l'Aluminium, le Plastique, l'Inox, etc. Ferramol® est présente sur les principaux marchés nationaux et internationaux, tant pour les grossistes que pour les fabricants de meubles. De même, la marque Ferramol® expose ses créations lors des foires internationales les plus importants.*

# GUÍA DE USO

## USER GUIDE

## MODE D'EMPLOI

## BENUTZERHANDBUCH

Tipología de producto  
*Product typology*  
*Typologie du produit*  
*Produkttyp*

Ambiente  
*Setting*  
*Ambiance*  
*Ambiente*



Nº de página  
*Page number*  
*Numéro de page*  
*Seitenzahl*



Fotografía de producto  
 Product photography  
 Photographie de produits  
 Produktfoto



Colores disponible  
 Available colours  
 Couleurs disponibles  
 Erhältliche Farben

ÁREA TÉCNICA • TECHNICAL AREA • DOMAINE TECHNIQUE • TECHNISCHER BEREICH

PATENTED - Nº 0531273 | Design: Gauzak

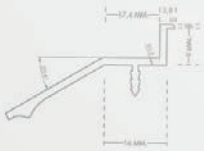

Ref. 73  
 Aluminio/Aluminium

81	82	L	
Blanco mate Matt white Blanc mat Mattes weiß	Negro mate Matt blk Noir mat Mattes Schwarz	Largo Length Long Lang	
73 015 81	73 015 82	147 MM.	25 pz./box
73 020 81	73 020 82	197 MM.	25 pz./box
73 025 81	73 025 82	247 MM.	25 pz./box
73 030 81	73 030 82	297 MM.	25 pz./box
73 035 81	73 035 82	347 MM.	25 pz./box
73 040 81	73 040 82	397 MM.	25 pz./box
73 045 81	73 045 82	447 MM.	25 pz./box
73 050 81	73 050 82	497 MM.	25 pz./box
73 070 81	73 070 82	597 MM.	25 pz./box
73 070 81	73 070 82	697 MM.	25 pz./box
73 080 81	73 080 82	797 MM.	25 pz./box
73 090 81	73 090 82	897 MM.	25 pz./box
73 100 81	73 100 82	997 MM.	25 pz./box
73 120 81	73 120 82	1197 MM.	25 pz./box

Packaging

Dibujo técnico  
 Technical drawing  
 Dessin technique  
 Technische Zeichnung

Código producto  
 Product code  
 Code produit  
 Produktcode

# ÍNDICE

## 0 GAMA DE COLORES COLOUR RANGE • PALETTE • FARBSPEKTRUM

	<i>Pag.</i>
<b>C</b> Colores	<b>14</b>

## 1 NOVEDADES NEW • NEUVE • NEUHEIT

<i>Serie</i>	<i>Pag.</i>
<b>7</b> 70	<b>28</b>
71	<b>32</b>
72	<b>36</b>
73	<b>40</b>
74	<b>44</b>
75	<b>48</b>
76	<b>16</b>
77	<b>20</b>
78	<b>24</b>

## 2 UÑEROS INTEGRATED HANDLES • LES ONGLES • GRIFFLEISTEN

	<i>Serie</i>	<i>Pag.</i>
<b>2</b>	26	<b>62</b>
	27	<b>70</b>
<b>3</b>	31	<b>71</b>
	32	<b>67</b>
	34	<b>66</b>
	35	<b>64</b>
	36	<b>68</b>
	37	<b>69</b>
<b>4</b>	44	<b>60</b>
	45	<b>56</b>
<b>5</b>	55	<b>52</b>
<b>100</b>	193	<b>72</b>

**3 TIRADORES**

HANDLES • POIGNÉE • GRIFFE

	<i>Serie</i>	<i>Pag.</i>
<b>5</b>	58	<b>84</b>
<b>6</b>	60	<b>82</b>
	61	<b>83</b>
	62	<b>88</b>
	63	<b>74</b>
	65	<b>122</b>
	66	<b>78</b>
	67	<b>124</b>
<b>27</b>	2740	<b>118</b>
	2741	<b>118</b>
	2745	<b>119</b>
	2746	<b>119</b>
	2775	<b>90</b>
	2785	<b>121</b>
	2795	<b>102</b>
<b>28</b>	2800	<b>98</b>
	2810	<b>117</b>
	2815	<b>116</b>
	2820	<b>115</b>
	2825	<b>114</b>
	2830	<b>113</b>
	2835	<b>112</b>
	2840	<b>111</b>
	2845	<b>110</b>
	2850	<b>108</b>
	2860	<b>106</b>
	2880	<b>94</b>
	2885	<b>109</b>
	2890	<b>96</b>
	2895	<b>105</b>
<b>29</b>	2900	<b>104</b>
	2905	<b>103</b>
<b>62</b>	6220	<b>120</b>
	6240	<b>120</b>

**4 CLÁSICOS**

CLASSICS • CLASSIQUES • KLASSIKER

	<i>Serie</i>	<i>Pag.</i>
<b>22</b>	2210	<b>139</b>
	2211	<b>144</b>
	2212	<b>145</b>
	2216	<b>141</b>
	2217	<b>140</b>
	2218	<b>142</b>
	2219	<b>143</b>
<b>26</b>	2660	<b>137</b>
	2663	<b>135</b>
<b>27</b>	2701	<b>132</b>
	2703	<b>133</b>
	2706	<b>128</b>
	2707	<b>126</b>
	2708	<b>130</b>
	2735	<b>134</b>
<b>30</b>	3080	<b>136</b>
	3090	<b>138</b>





COLLECTION • 2024

# TIRA DORES



HANDLES  
POIGNÉES  
GRIFFELEMEN

## GAMA DE COLORES



**00** Oro brillo  
Shine gold  
Or brillant  
Helles gold



**02** Cromo brillo  
Shine chrome  
Chrome brillant  
Helles chrom



**07** Cromo mate  
Matt chrome  
Chrome mat  
Helles chrom



**03** Cobre viejo  
Old cooper  
Vieux cuivre  
Altes kupfer



**04** Oro viejo  
Old gold  
Vieux or  
Altes gold



**05** Plata vieja  
Old silver  
Vieux argent  
Altes silber

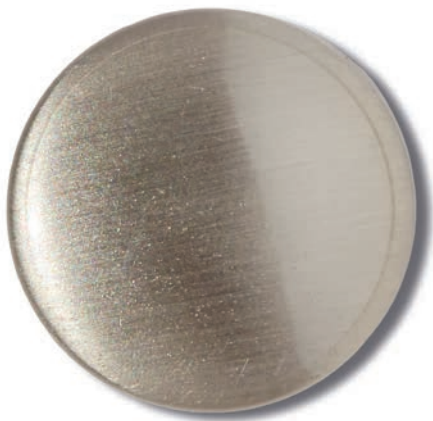

**08** Niquel satinado  
Satin nickel  
Nickel satiné  
Satiniertes nickel



**14** Oro satinado  
Satin gold  
Or satiné  
Satin gold



**01** Titanio  
Titanium  
Titane  
Titan

## RANGE COLOURS • GAMME DE COULEURS • FARBSPEKTRUM



**71** *Blanco brillo*  
*Shine white*  
*Blanc brillante*  
*Helles weiß*



**81** *Blanco mate*  
*Matt white*  
*Blanc mat*  
*Mattes weiß*



**82** *Negro mate*  
*Matt black*  
*Noir mat*  
*Mattes schwarz*



**83** *Antracita*  
*Anthracite*  
*Anthracite*  
*Anthrazit*



**94** *Oro viejo rústico*  
*Rustic old gold*  
*Rustic vieux or*  
*Rustikales alt-gold*



**95** *Plata vieja rústica*  
*Rustic old silver*  
*Rustic vieux argent*  
*Rustikales alt-silver*



**96** *Epoxi níquel mate*  
*Epoxi matt nickel*  
*Epoxi nickel satin*  
*Ep satiniertes nickel*



**97** *Epoxi cromo mate*  
*Epoxi Matt chrome*  
*Epoxi Chrome mat*  
*Epoxi Helles chrome*















ÁREA TÉCNICA • TECHNICAL AREA • DOMAINE TECHNIQUE • TECHNISCHER BEREICH

Design: Gauzak

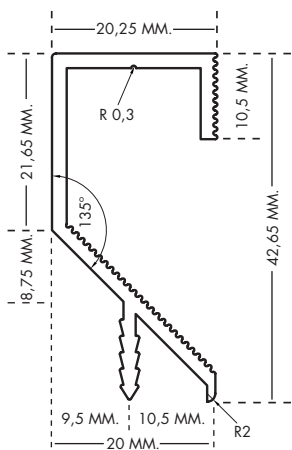

Ref. 76

Material: Aluminium

FINISHES

14	82	L	
<i>Oro satinado</i>	<i>Negro mate</i>	<i>Largo</i>	
<i>Satin gold</i>	<i>Matt blk</i>	<i>Lenght</i>	
<i>Or satiné</i>	<i>Noir mat</i>	<i>Long</i>	
<i>Satin gold</i>	<i>Mattes Schwarz</i>	<i>Lang</i>	
<b>76 015 14</b>	<b>76 015 82</b>	147 MM.	25 pz./box
<b>76 020 14</b>	<b>76 020 82</b>	197 MM.	25 pz./box
<b>76 025 14</b>	<b>76 025 82</b>	247 MM.	25 pz./box
<b>76 030 14</b>	<b>76 030 82</b>	297 MM.	25 pz./box
<b>76 035 14</b>	<b>76 035 82</b>	347 MM.	25 pz./box
<b>76 040 14</b>	<b>76 040 82</b>	397 MM.	25 pz./box
<b>76 045 14</b>	<b>76 045 82</b>	447 MM.	25 pz./box
<b>76 050 14</b>	<b>76 050 82</b>	497 MM.	25 pz./box
<b>76 060 14</b>	<b>76 076 82</b>	597 MM.	25 pz./box
<b>76 070 14</b>	<b>76 070 82</b>	697 MM.	15 pz./box
<b>76 080 14</b>	<b>76 080 82</b>	797 MM.	15 pz./box
<b>76 090 14</b>	<b>76 090 82</b>	897 MM.	15 pz./box
<b>76 100 14</b>	<b>76 100 82</b>	997 MM.	15 pz./box
<b>76 120 14</b>	<b>76 120 82</b>	1197 MM.	15 pz./box













## ÁREA TÉCNICA • TECHNICAL AREA • DOMAINE TECHNIQUE • TECHNISCHER BEREICH

Design: Gauzak

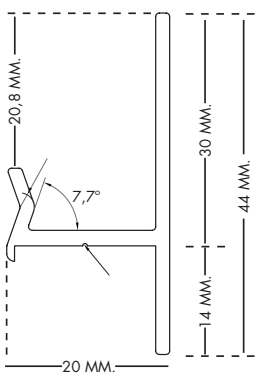

**Ref. 77**  
Material: Aluminium

### FINISHES

07	82	L	
<i>Cromo mate</i>	<i>Negro mate</i>	<i>Largo</i>	
<i>Matt chrome</i>	<i>Matt blk</i>	<i>Lenght</i>	
<i>Chrome mat</i>	<i>Noir mat</i>	<i>Long</i>	
<i>Helles chrom</i>	<i>Mattes Schwarz</i>	<i>Lang</i>	
<b>77 300 07</b>	<b>77 300 82</b>	2950 MM.	10 pz./box











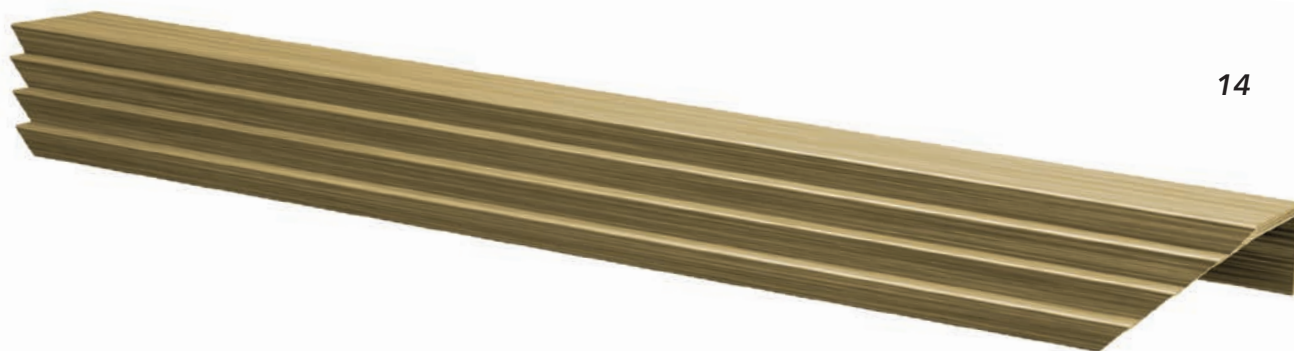

14



82

ÁREA TÉCNICA • TECHNICAL AREA • DOMAINE TECHNIQUE • TECHNISCHER BEREICH

Design: Gauzak

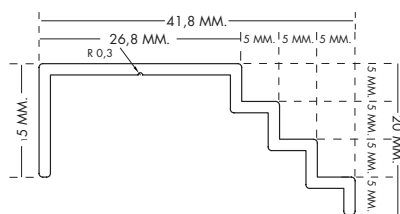

tornillos de sujeción • fastening screws  
vis de fixation • befestigungsschrauben

Ref. 78  
Material: Aluminium

FINISHES						
01	14	81	82	L	⊕	⊖
<i>Titanio</i>	<i>Oro satinado</i>	<i>Blanco mate</i>	<i>Negro mate</i>	<i>Largo</i>	<i>Tornillos</i>	
<i>Titanium</i>	<i>Satin gold</i>	<i>Matt white</i>	<i>Matt blk</i>	<i>Lenght</i>	<i>Screws</i>	
<i>Titane</i>	<i>Or satiné</i>	<i>Blanc mat</i>	<i>Noir mat</i>	<i>Long</i>	<i>Des vis</i>	
<i>Titan</i>	<i>Satin gold</i>	<i>Mattes weiß</i>	<i>Mattes Schwarz</i>	<i>Lang</i>	<i>Seiten</i>	
78 010 01	78 010 14	78 010 81	78 010 82	97 MM.	64 MM.	50 pz./box
78 020 01	78 020 14	78 020 81	78 020 82	197 MM.	128 MM.	50 pz./box
78 035 01	78 035 14	78 035 81	78 035 82	347 MM.	192 MM.	50 pz./box















ÁREA TÉCNICA • TECHNICAL AREA • DOMAINE TECHNIQUE • TECHNISCHER BEREICH

PATENTED - N° 0531273 | Design: Gauzak

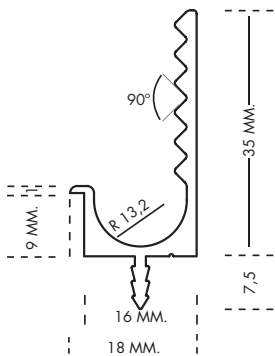

**Ref. 70**  
Material: Aluminium

**FINISHES**

07	08	81	82	L	
<i>Cromo mate</i>	<i>Niquel satinado</i>	<i>Blanco mate</i>	<i>Negro mate</i>	<i>Largo</i>	
<i>Matt chrome</i>	<i>Satin nickel</i>	<i>Matt white</i>	<i>Matt blk</i>	<i>Lenght</i>	
<i>Chrome mat</i>	<i>Nickel satiné</i>	<i>Blanc mat</i>	<i>Noir mat</i>	<i>Long</i>	
<i>Helles chrom</i>	<i>Satiniertes nickel</i>	<i>Mattes weiß</i>	<i>Mattes Schwarz</i>	<i>Lang</i>	
<b>70 015 07</b>	<b>70 015 08</b>	<b>70 015 81</b>	<b>70 015 82</b>	147 MM.	
<b>70 020 07</b>	<b>70 020 08</b>	<b>70 020 81</b>	<b>70 020 82</b>	197 MM.	25 pz./box
<b>70 025 07</b>	<b>70 025 08</b>	<b>70 025 81</b>	<b>70 025 82</b>	247 MM.	25 pz./box
<b>70 030 07</b>	<b>70 030 08</b>	<b>70 030 81</b>	<b>70 030 82</b>	297 MM.	25 pz./box
<b>70 035 07</b>	<b>70 035 08</b>	<b>70 035 81</b>	<b>70 035 82</b>	347 MM.	25 pz./box
<b>70 040 07</b>	<b>70 040 08</b>	<b>70 040 81</b>	<b>70 040 82</b>	397 MM.	25 pz./box
<b>70 045 07</b>	<b>70 045 08</b>	<b>70 045 81</b>	<b>70 045 82</b>	447 MM.	25 pz./box
<b>70 050 07</b>	<b>70 050 08</b>	<b>70 050 81</b>	<b>70 050 82</b>	497 MM.	25 pz./box
<b>70 070 07</b>	<b>70 070 08</b>	<b>70 070 81</b>	<b>70 070 82</b>	597 MM.	25 pz./box
<b>70 070 07</b>	<b>70 070 08</b>	<b>70 070 81</b>	<b>70 070 82</b>	697 MM.	25 pz./box
<b>70 080 07</b>	<b>70 080 08</b>	<b>70 080 81</b>	<b>70 080 82</b>	797 MM.	25 pz./box
<b>70 090 07</b>	<b>70 090 08</b>	<b>70 090 81</b>	<b>70 090 82</b>	897 MM.	25 pz./box
<b>70 100 07</b>	<b>70 100 08</b>	<b>70 100 81</b>	<b>70 100 82</b>	997 MM.	25 pz./box
<b>70 120 07</b>	<b>70 120 08</b>	<b>70 120 81</b>	<b>70 120 82</b>	1197 MM.	25 pz./box
<b>70 300 07</b>	<b>70 300 08</b>	<b>70 300 81</b>	<b>70 300 82</b>	2950 MM.	10 pz./box













82

ÁREA TÉCNICA • TECHNICAL AREA • DOMAINE TECHNIQUE • TECHNISCHER BEREICH

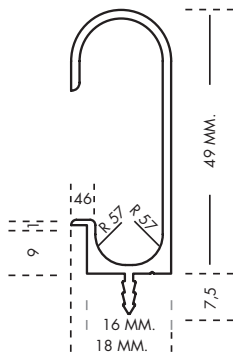
PATENTED - N° 0531273 | Design: Gauzak



Ref. 71  
Aluminio/Aluminium

07	81	82	L	
<i>Cromo mate</i> <i>Matt chrome</i> <i>Chrome mat</i> <i>Helles chrom</i>	<i>Blanco mate</i> <i>Matt white</i> <i>Blanc mat</i> <i>Mattes weiß</i>	<i>Negro mate</i> <i>Matt blk</i> <i>Noir mat</i> <i>Mattes Schwarz</i>	<i>Largo</i> <i>Lenght</i> <i>Long</i> <i>Lang</i>	
71 015 07	71 015 81	71 015 82	147 MM.	25 pz./box
71 020 07	71 020 81	71 020 82	197 MM.	25 pz./box
71 025 07	71 025 81	71 025 82	247 MM.	25 pz./box
71 030 07	71 030 81	71 030 82	297 MM.	25 pz./box
71 035 07	71 035 81	71 035 82	347 MM.	25 pz./box
71 040 07	71 040 81	71 040 82	397 MM.	25 pz./box
71 045 07	71 045 81	71 045 82	447 MM.	25 pz./box
71 050 07	71 050 81	71 050 82	497 MM.	25 pz./box
71 070 07	71 070 81	71 070 82	597 MM.	25 pz./box
71 070 07	71 070 81	71 070 82	697 MM.	10 pz./box
71 080 07	71 080 81	71 080 82	797 MM.	10 pz./box
71 090 07	71 090 81	71 090 82	897 MM.	10 pz./box
71 100 07	71 100 81	71 100 82	997 MM.	10 pz./box
71 120 07	71 120 81	71 120 82	1197 MM.	10 pz./box
71 300 07	71 300 81	71 300 82	2950 MM.	10 pz./box













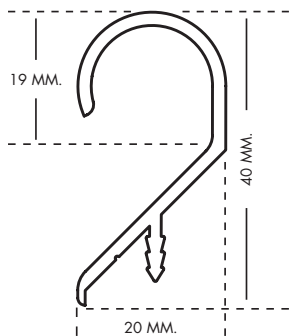

**ÁREA TÉCNICA • TECHNICAL AREA • DOMAINE TECHNIQUE • TECHNISCHER BEREICH**

PATENTED - N° 0531273 | Design: Gauzak



**Ref. 72**  
Aluminio/Aluminium

07	14	81	82	L	
<i>Cromo mate</i> <i>Matt chrome</i> <i>Chrome mat</i> <i>Helles chrom</i>	<i>Oro satinado</i> <i>Satin gold</i> <i>Or satiné</i> <i>Satin gold</i>	<i>Blanco mate</i> <i>Matt white</i> <i>Blanc mat</i> <i>Mattes weiß</i>	<i>Negro mate</i> <i>Matt blk</i> <i>Noir mat</i> <i>Mattes Schwarz</i>	<i>Largo</i> <i>Lenght</i> <i>Long</i> <i>Lang</i>	
72 015 07	72 015 14	72 015 81	72 015 82	147 MM.	25 pz./box
72 020 07	72 020 14	72 020 81	72 020 82	197 MM.	25 pz./box
72 025 07	72 025 14	72 025 81	72 025 82	247 MM.	25 pz./box
72 030 07	72 030 14	72 030 81	72 030 82	297 MM.	25 pz./box
72 035 07	72 035 14	72 035 81	72 035 82	347 MM.	25 pz./box
72 040 07	72 040 14	72 040 81	72 040 82	397 MM.	25 pz./box
72 045 07	72 045 14	72 045 81	72 045 82	447 MM.	25 pz./box
72 050 07	72 050 14	72 050 81	72 050 82	497 MM.	25 pz./box
72 070 07	72 070 14	72 070 81	72 070 82	597 MM.	25 pz./box
72 070 07	72 070 14	72 070 81	72 070 82	697 MM.	15 pz./box
72 080 07	72 080 14	72 080 81	72 080 82	797 MM.	15 pz./box
72 090 07	72 090 14	72 090 81	72 090 82	897 MM.	15 pz./box
72 100 07	72 100 14	72 100 81	72 100 82	997 MM.	15 pz./box
72 120 07	72 120 14	72 120 81	72 120 82	1197 MM.	15 pz./box
72 300 07	---	72 300 81	72 300 82	2950 MM.	10 pz./box















82

ÁREA TÉCNICA • TECHNICAL AREA • DOMAINE TECHNIQUE • TECHNISCHER BEREICH

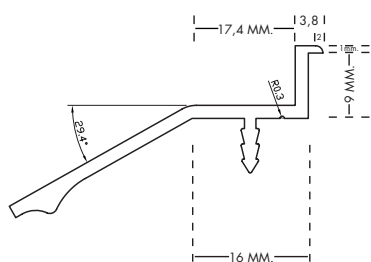
PATENTED - N° 0531273 | Design: Gauzak



**Ref. 73**  
Aluminio/Aluminium

81	82	L	
<i>Blanco mate</i> <i>Matt white</i> <i>Blanc mat</i> <i>Mattes weiß</i>	<i>Negro mate</i> <i>Matt blk</i> <i>Noir mat</i> <i>Mattes Schwarz</i>	<i>Largo</i> <i>Lenght</i> <i>Long</i> <i>Lang</i>	
73 015 81	73 015 82	147 MM.	25 pz./box
73 020 81	73 020 82	197 MM.	25 pz./box
73 025 81	73 025 82	247 MM.	25 pz./box
73 030 81	73 030 82	297 MM.	25 pz./box
73 035 81	73 035 82	347 MM.	25 pz./box
73 040 81	73 040 82	397 MM.	25 pz./box
73 045 81	73 045 82	447 MM.	25 pz./box
73 050 81	73 050 82	497 MM.	25 pz./box
73 070 81	73 070 82	597 MM.	25 pz./box
73 070 81	73 070 82	697 MM.	25 pz./box
73 080 81	73 080 82	797 MM.	25 pz./box
73 090 81	73 090 82	897 MM.	25 pz./box
73 100 81	73 100 82	997 MM.	25 pz./box
73 120 81	73 120 82	1197 MM.	25 pz./box









07

82



ÁREA TÉCNICA • TECHNICAL AREA • DOMAINE TECHNIQUE • TECHNISCHER BEREICH

PATENTED - N° 0531273 | Design: Gauzak

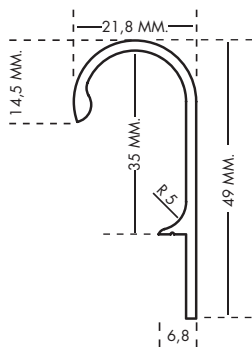

Ref. 74  
Aluminio/Aluminium

07	81	82	L	
<i>Cromo mate</i> <i>Matt chrome</i> <i>Chrome mat</i> <i>Helles chrom</i>	<i>Blanco mate</i> <i>Matt white</i> <i>Blanc mat</i> <i>Mattes weiß</i>	<i>Negro mate</i> <i>Matt blk</i> <i>Noir mat</i> <i>Mattes Schwarz</i>	<i>Largo</i> <i>Lenght</i> <i>Long</i> <i>Lang</i>	
74015 07	74015 81	74015 82	147 MM.	25 pz./box
74020 07	74020 81	74020 82	197 MM.	25 pz./box
74025 07	74025 81	74025 82	247 MM.	25 pz./box
74030 07	74030 81	74030 82	297 MM.	25 pz./box
74035 07	74035 81	74035 82	347 MM.	25 pz./box
74040 07	74040 81	74040 82	397 MM.	25 pz./box
74045 07	74045 81	74045 82	447 MM.	25 pz./box
74050 07	74050 81	74050 82	497 MM.	25 pz./box
74060 07	74060 81	74060 82	597 MM.	25 pz./box
74070 07	74070 81	74070 82	697 MM.	15 pz./box
74080 07	74080 81	74080 82	797 MM.	15 pz./box
74090 07	74090 81	74090 82	897 MM.	15 pz./box
74100 07	74100 81	74100 82	997 MM.	15 pz./box
74120 07	74120 81	74120 82	1197 MM.	15 pz./box
74300 07	74300 81	74300 82	2950 MM.	10 pz./box









82



**ÁREA TÉCNICA • TECHNICAL AREA • DOMAINE TECHNIQUE • TECHNISCHER BEREICH**

PATENTED - N° 0531273 | Design: Gauzak

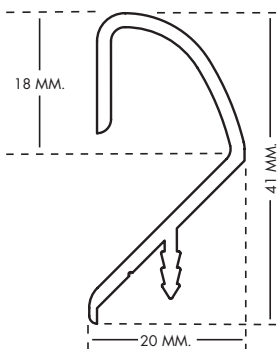

**Ref. 75**  
Aluminio/Aluminium

07	81	82	L	
<i>Cromo mate</i> <i>Matt chrome</i> <i>Chrome mat</i> <i>Helles chrom</i>	<i>Blanco mate</i> <i>Matt white</i> <i>Blanc mat</i> <i>Mattes weiß</i>	<i>Negro mate</i> <i>Matt blk</i> <i>Noir mat</i> <i>Mattes Schwarz</i>	<i>Largo</i> <i>Lenght</i> <i>Long</i> <i>Lang</i>	
75015 07	75015 81	75015 82	147 MM.	25 pz./box
75020 07	75020 81	75020 82	197 MM.	25 pz./box
75025 07	75025 81	75025 82	247 MM.	25 pz./box
75030 07	75030 81	75030 82	297 MM.	25 pz./box
75035 07	75035 81	75035 82	347 MM.	25 pz./box
75040 07	75040 81	75040 82	397 MM.	25 pz./box
75045 07	75045 81	75045 82	447 MM.	25 pz./box
75050 07	75050 81	75050 82	497 MM.	25 pz./box
75060 07	75060 81	75060 82	597 MM.	25 pz./box
75070 07	75070 81	75070 82	697 MM.	15 pz./box
75080 07	75080 81	75080 82	797 MM.	15 pz./box
75090 07	75090 81	75090 82	897 MM.	15 pz./box
75100 07	75100 81	75100 82	997 MM.	15 pz./box
75120 07	75120 81	75120 82	1197 MM.	15 pz./box
75300 07	75300 81	75300 82	2950 MM.	10 pz./box













82

**ÁREA TÉCNICA • TECHNICAL AREA • DOMAINE TECHNIQUE • TECHNISCHER BEREICH**

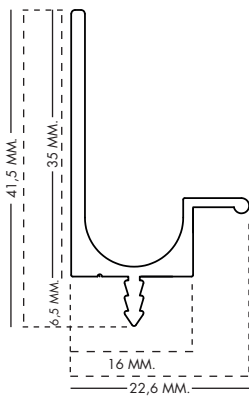
Design: Ferramol®

**Ref. 55**

Material: Aluminium

<b>81</b>	<b>82</b>	<b>L</b>	
<i>Blanco mate</i>	<i>Negro mate</i>	<i>Largo</i>	
<i>Matt white</i>	<i>Matt blk</i>	<i>Lenght</i>	
<i>Blanc mat</i>	<i>Noir mat</i>	<i>Long</i>	
<i>Mattes weiß</i>	<i>Mattes Schwarz</i>	<i>Lang</i>	
<b>55 015 81</b>	<b>55 015 82</b>	147 MM.	25 pz./box
<b>55 020 81</b>	<b>55 020 82</b>	197 MM.	25 pz./box
<b>55 025 81</b>	<b>55 025 82</b>	247 MM.	25 pz./box
<b>55 030 81</b>	<b>55 030 82</b>	297 MM.	25 pz./box
<b>55 035 81</b>	<b>55 035 82</b>	347 MM.	25 pz./box
<b>55 040 81</b>	<b>55 040 82</b>	397 MM.	25 pz./box
<b>55 045 81</b>	<b>55 045 82</b>	447 MM.	25 pz./box
<b>55 050 81</b>	<b>55 050 82</b>	497 MM.	25 pz./box
<b>55 070 81</b>	<b>55 070 82</b>	597 MM.	25 pz./box
<b>55 070 81</b>	<b>55 070 82</b>	697 MM.	25 pz./box
<b>55 080 81</b>	<b>55 080 82</b>	797 MM.	25 pz./box
<b>55 090 81</b>	<b>55 090 82</b>	897 MM.	25 pz./box
<b>55 100 81</b>	<b>55 100 82</b>	997 MM.	25 pz./box
<b>55 120 81</b>	<b>55 120 82</b>	1197 MM.	25 pz./box







ESPECIAL PUERTAS  
**19 mm.**



ÁREA TÉCNICA • TECHNICAL AREA • DOMAINE TECHNIQUE • TECHNISCHER BEREICH

Design: Ferramol®

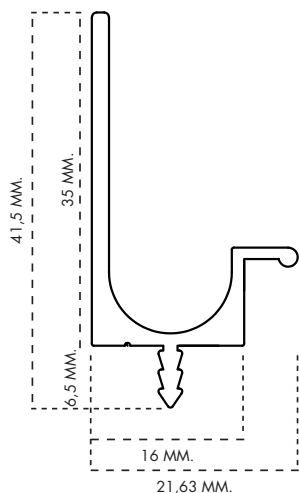

**Ref. 45**

Material: Aluminium

**FINISHES**

07	81	82	L	
<i>Cromo mate</i>	<i>Blanco mate</i>	<i>Negro mate</i>	<i>Largo</i>	
<i>Matt chrome</i>	<i>Matt white</i>	<i>Matt blk</i>	<i>Lenght</i>	
<i>Chrome mat</i>	<i>Blanc mat</i>	<i>Noir mat</i>	<i>Long</i>	
<i>Helles chrom</i>	<i>Mattes weiß</i>	<i>Mattes Schwarz</i>	<i>Lang</i>	
45 015 07	45 015 81	45 015 82	147 MM.	25 pz./box
45 020 07	45 020 81	45 020 82	197 MM.	25 pz./box
45 025 07	45 025 81	45 025 82	247 MM.	25 pz./box
45 030 07	45 030 81	45 030 82	297 MM.	25 pz./box
45 035 07	45 035 81	45 035 82	347 MM.	25 pz./box
45 040 07	45 040 81	45 040 82	397 MM.	25 pz./box
45 045 07	45 045 81	45 045 82	447 MM.	25 pz./box
45 050 07	45 050 81	45 050 82	497 MM.	25 pz./box
45 070 07	45 070 81	45 070 82	597 MM.	25 pz./box
45 070 07	45 070 81	45 070 82	697 MM.	25 pz./box
45 080 07	45 080 81	45 080 82	797 MM.	25 pz./box
45 090 07	45 090 81	45 090 82	897 MM.	25 pz./box
45 100 07	45 100 81	45 100 82	997 MM.	25 pz./box
45 120 07	45 120 81	45 120 82	1197 MM.	25 pz./box
45 300 07	45 300 81	45 300 82	2950 MM.	10 pz./box

**TERMINALES**

**Angle 45°**



**REF. 456**  
Right

**REF. 457**  
Left



**Angle 90°**

**REF. 458**  
Right

**REF. 459**  
Left

**ANGLE 45° TERMINALS RIGHT**

456 97	456 81	456 82	53 MM.	25 pz./box
--------	--------	--------	--------	------------

**ANGLE 45° TERMINALS LEFT**

457 97	457 81	457 82	53 MM.	25 pz./box
--------	--------	--------	--------	------------

**ANGLE 90° TERMINALS RIGHT**

458 97	458 81	458 82	13 MM.	25 pz./box
--------	--------	--------	--------	------------

**ANGLE 90° TERMINALS LEFT**

459 97	459 81	459 82	13 MM.	25 pz./box
--------	--------	--------	--------	------------

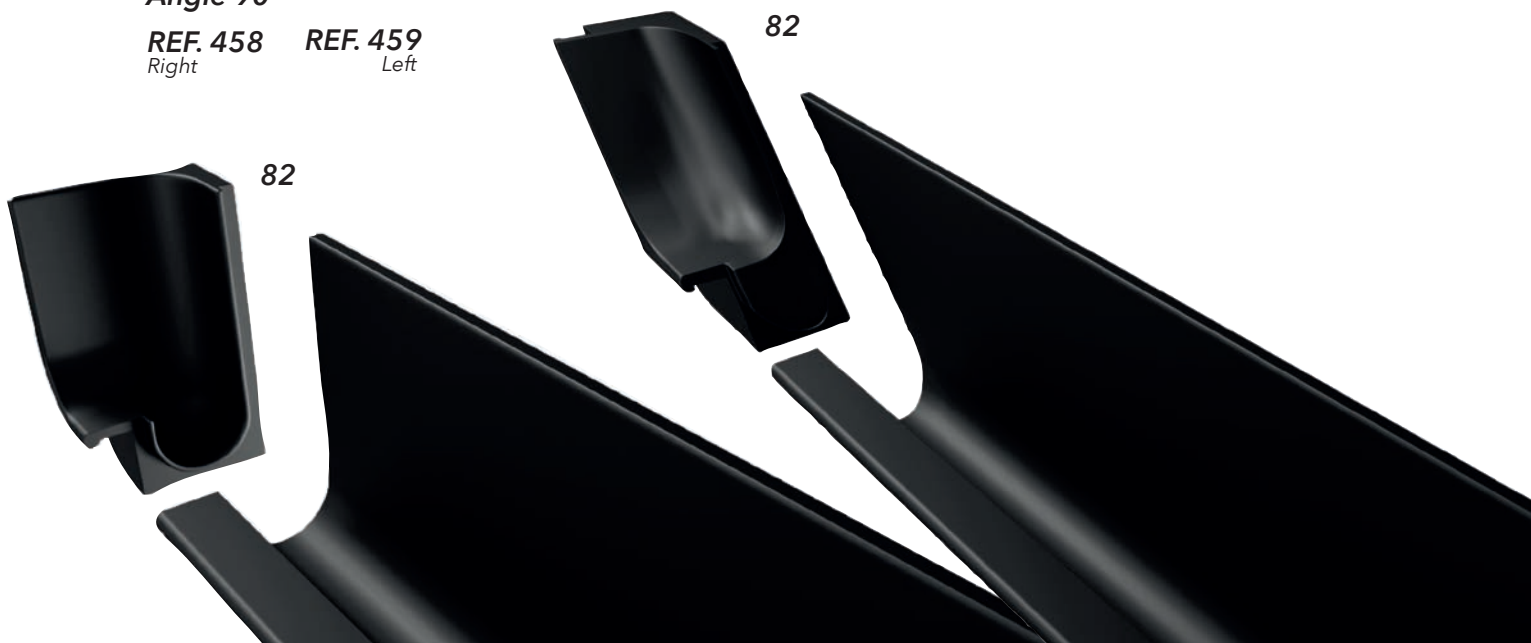







82

**TERMINALES**



**REF. 449**  
Left

**REF. 448**  
Right

**ÁREA TÉCNICA • TECHNICAL AREA • DOMAINE TECHNIQUE • TECHNISCHER BEREICH**

Design: Ferramol®

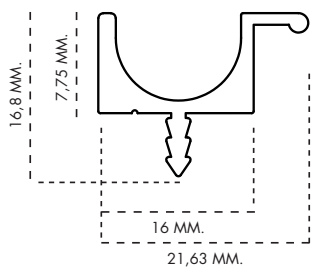

**Ref. 44**  
Material: Aluminium

<b>FINISHES</b>				
<b>07</b>	<b>81</b>	<b>82</b>	<b>L</b>	
<i>Cromo mate</i>	<i>Blanco mate</i>	<i>Negro mate</i>	<i>Largo</i>	
<i>Matt chrome</i>	<i>Matt white</i>	<i>Matt blk</i>	<i>Lenght</i>	
<i>Chrome mat</i>	<i>Blanc mat</i>	<i>Noir mat</i>	<i>Long</i>	
<i>Helles chrom</i>	<i>Mattes weiß</i>	<i>Mattes Schwarz</i>	<i>Lang</i>	
<b>44 300 07</b>	<b>44 300 81</b>	<b>44 300 82</b>	2950 MM.	
<b>TERMINALS</b>				
<b>RIGHT</b>			<b>A</b>	
<b>448 97</b>	<b>448 81</b>	<b>448 82</b>	21,6 MM.	25 pz./box
<b>LEFT</b>			<b>A</b>	
<b>449 97</b>	<b>449 81</b>	<b>449 82</b>	21,6 MM.	25 pz./box



**ÁREA TÉCNICA • TECHNICAL AREA • DOMAINE TECHNIQUE • TECHNISCHER BEREICH**

Design: Ferramol®

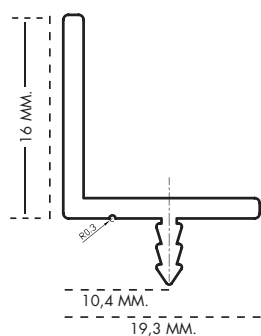
**Ref. 26**

Material: Aluminium

**FINISHES**

81	82	L	
<i>Blanco mate</i>	<i>Negro mate</i>	<i>Largo</i>	
<i>Matt white</i>	<i>Matt blk</i>	<i>Lenght</i>	
<i>Blanc mat</i>	<i>Noir mat</i>	<i>Long</i>	
<i>Mattes weiß</i>	<i>Mattes Schwarz</i>	<i>Lang</i>	
<b>26 015 81</b>	<b>26 015 82</b>	147 MM.	25 pz./box
<b>26 020 81</b>	<b>26 020 82</b>	197 MM.	25 pz./box
<b>26 025 81</b>	<b>26 025 82</b>	247 MM.	25 pz./box
<b>26 030 81</b>	<b>26 030 82</b>	297 MM.	25 pz./box
<b>26 035 81</b>	<b>26 035 82</b>	347 MM.	25 pz./box
<b>26 040 81</b>	<b>26 040 82</b>	397 MM.	25 pz./box
<b>26 045 81</b>	<b>26 045 82</b>	447 MM.	25 pz./box
<b>26 050 81</b>	<b>26 050 82</b>	497 MM.	25 pz./box
<b>26 070 81</b>	<b>26 070 82</b>	597 MM.	25 pz./box
<b>26 070 81</b>	<b>26 070 82</b>	697 MM.	25 pz./box
<b>26 080 81</b>	<b>26 080 82</b>	797 MM.	25 pz./box
<b>26 090 81</b>	<b>26 090 82</b>	897 MM.	25 pz./box
<b>26 100 81</b>	<b>26 100 82</b>	997 MM.	25 pz./box
<b>26 120 81</b>	<b>26 120 82</b>	1197 MM.	25 pz./box



Design: Ferramol®

**Ref. 35**  
Aluminio/Aluminium

FINISHES				
07	14	18	L	
<i>Cromo mate</i> <i>Matt chrome</i> <i>Chrome mat</i> <i>Helles chrom</i>	<i>Oro satinado</i> <i>Satin gold</i> <i>Or satiné</i> <i>Satin gold</i>	<i>Niquel satinado</i> <i>Satin nickel</i> <i>Nickel satiné</i> <i>Satiniertes nickel</i>	<i>Largo</i> <i>Lenght</i> <i>Long</i> <i>Lang</i>	
35 015 07	35 015 14	35 015 18	147 MM.	25 pz./box
35 020 07	35 020 14	35 020 18	197 MM.	25 pz./box
35 025 07	35 025 14	35 025 18	247 MM.	25 pz./box
35 030 07	35 030 14	35 030 18	297 MM.	25 pz./box
35 035 07	35 035 14	35 035 18	347 MM.	25 pz./box
35 040 07	35 040 14	35 040 18	397 MM.	25 pz./box
35 045 07	35 045 14	35 045 18	447 MM.	25 pz./box
35 050 07	35 050 14	35 050 18	497 MM.	25 pz./box
35 070 07	35 070 14	35 070 18	597 MM.	25 pz./box
35 070 07	35 070 14	35 070 18	697 MM.	25 pz./box
35 080 07	35 080 14	35 080 18	797 MM.	25 pz./box
35 090 07	35 090 14	35 090 18	897 MM.	25 pz./box
35 100 07	35 100 14	35 100 18	997 MM.	25 pz./box
35 120 07	35 120 14	35 120 18	1197 MM.	25 pz./box
35 300 07	---	35 300 18	2950 MM.	10 pz./box

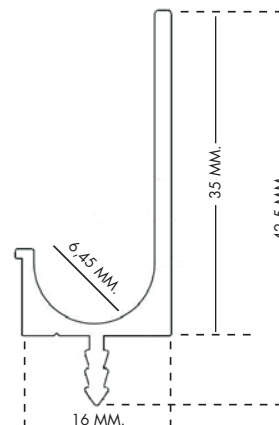

FINISHES				
71	81	82	83	L
<i>Blanco brillo</i> <i>Shine white</i> <i>Blanc brillant</i> <i>Helles weiß</i>	<i>Blanco mate</i> <i>Matt white</i> <i>Blanc mat</i> <i>Mattes weiß</i>	<i>Negro mate</i> <i>Matt blk</i> <i>Noir mat</i> <i>Mattes Schwarz</i>	<i>Antracita</i> <i>Anthracite</i> <i>Anthracite</i> <i>Anthracite</i>	<i>Largo</i> <i>Lenght</i> <i>Long</i> <i>Lang</i>
35 015 71	35 015 81	35 015 82	35 015 83	147 MM.
35 020 71	35 020 81	35 020 82	35 020 83	197 MM.
35 025 71	35 025 81	35 025 82	35 025 83	247 MM.
35 030 71	35 030 81	35 030 82	35 030 83	297 MM.
35 035 71	35 035 81	35 035 82	35 035 83	347 MM.
35 040 71	35 040 81	35 040 82	35 040 83	397 MM.
35 045 71	35 045 81	35 045 82	35 045 83	447 MM.
35 050 71	35 050 81	35 050 82	35 050 83	497 MM.
35 070 71	35 070 81	35 070 82	35 070 83	597 MM.
35 070 71	35 070 81	35 070 82	35 070 83	697 MM.
35 080 71	35 080 81	35 080 82	35 080 83	797 MM.
35 090 71	35 090 81	35 090 82	35 090 83	897 MM.
35 100 71	35 100 81	35 100 82	35 100 83	997 MM.
35 120 71	35 120 81	35 120 82	35 120 83	1197 MM.
35 300 71	35 300 81	35 300 82	---	2950 MM.



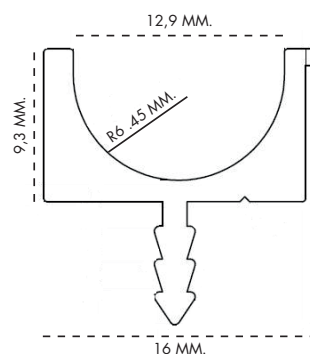

**ÁREA TÉCNICA • TECHNICAL AREA • DOMAINE TECHNIQUE • TECHNISCHER BEREICH**

Design: Ferramol®

**Ref. 34**

Aluminio/Aluminium

**FINISHES**

07	18	71	81	82	83	L	
<i>Cromo mate</i> <i>Matt chrome</i> <i>Chrome mat</i> <i>Helles chrom</i>	<i>Niquel satinado</i> <i>Satin nickel</i> <i>Nickel satiné</i> <i>Satiniertes nickel</i>	<i>Blanco brillo</i> <i>Shine white</i> <i>Blanc brillant</i> <i>Helles weiß</i>	<i>Blanco mate</i> <i>Matt white</i> <i>Blanc mat</i> <i>Mattes weiß</i>	<i>Negro mate</i> <i>Matt blk</i> <i>Noir mat</i> <i>Mattes Schwarz</i>	<i>Antracita</i> <i>Anthracite</i> <i>Anthracite</i> <i>Anthracite</i>	<i>Largo</i> <i>Lenght</i> <i>Long</i> <i>Lang</i>	
34 015 07	34 015 18	34 015 71	34 015 81	34 015 82	34 015 83	147 MM.	25 pz./box
34 020 07	34 020 18	34 020 71	34 020 81	34 020 82	34 020 83	197 MM.	25 pz./box
34 025 07	34 025 18	34 025 71	34 025 81	34 025 82	34 025 83	247 MM.	25 pz./box
34 030 07	34 030 18	34 030 71	34 030 81	34 030 82	34 030 83	297 MM.	25 pz./box
34 034 07	34 034 18	34 035 71	34 035 81	34 035 82	34 035 83	347 MM.	25 pz./box
34 040 07	34 040 18	34 040 71	34 040 81	34 040 82	34 040 83	397 MM.	25 pz./box
34 045 07	34 045 18	34 045 71	34 045 81	34 045 82	34 045 83	447 MM.	25 pz./box
34 050 07	34 050 18	34 050 71	34 050 81	34 050 82	34 050 83	497 MM.	25 pz./box
34 070 07	34 070 18	34 070 71	34 070 81	34 070 82	34 070 83	597 MM.	25 pz./box
34 070 07	34 070 18	34 070 71	34 070 81	34 070 82	34 070 83	697 MM.	25 pz./box
34 080 07	34 080 18	34 080 71	34 080 81	34 080 82	34 080 83	797 MM.	25 pz./box
34 090 07	34 090 18	34 090 71	34 090 81	34 090 82	34 090 83	897 MM.	25 pz./box
34 100 07	34 100 18	34 100 71	34 100 81	34 100 82	34 100 83	997 MM.	25 pz./box
34 120 07	34 120 18	34 120 71	34 120 81	34 120 82	34 120 83	1197 MM.	25 pz./box
34 300 07	34 300 18	34 300 71	34 300 81	34 300 82	---	2950 MM.	10 pz./box



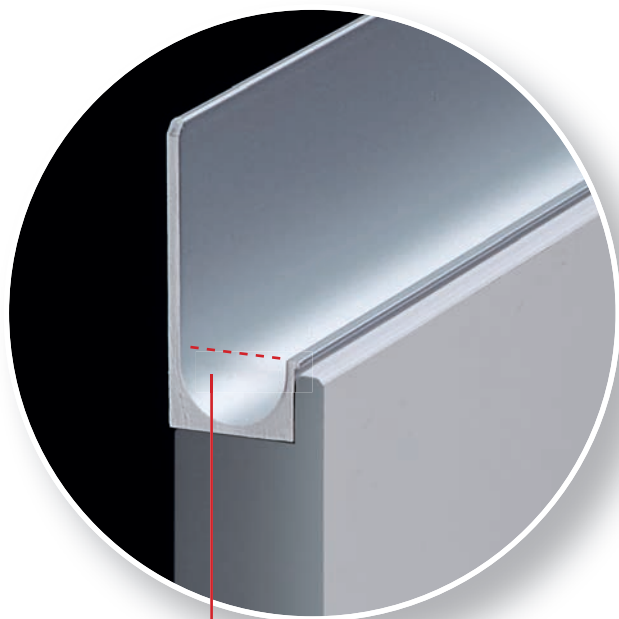

**14 MM.**  
ESPECIAL PUERTAS "SLIM"

**ÁREA TÉCNICA • TECHNICAL AREA • DOMAINE TECHNIQUE • TECHNISCHER BEREICH**

Design: Ferramol®

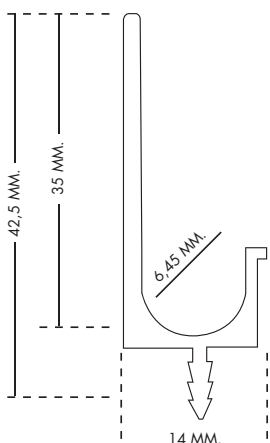

**Ref. 34**  
Aluminio/Aluminium

**FINISHES**

07	81	L	
<i>Cromo mate</i> <i>Matt chrome</i> <i>Chrome mat</i> <i>Helles chrom</i>	<i>Blanco mate</i> <i>Matt white</i> <i>Blanc mat</i> <i>Mattes weiß</i>	<i>Largo</i> <i>Lenght</i> <i>Long</i> <i>Lang</i>	
32 015 07	32 015 81	147 MM.	25 pz./box
32 020 07	32 020 81	197 MM.	25 pz./box
32 025 07	32 025 81	247 MM.	25 pz./box
32 030 07	32 030 81	297 MM.	25 pz./box
32 035 07	32 035 81	347 MM.	25 pz./box
32 040 07	32 040 81	397 MM.	25 pz./box
32 045 07	32 045 81	447 MM.	25 pz./box
32 050 07	32 050 81	497 MM.	25 pz./box
32 070 07	32 070 81	597 MM.	25 pz./box
32 070 07	32 070 81	697 MM.	25 pz./box
32 080 07	32 080 81	797 MM.	25 pz./box
32 090 07	32 090 81	897 MM.	25 pz./box
32 100 07	32 100 81	997 MM.	25 pz./box
32 120 07	32 120 81	1197 MM.	25 pz./box
32 300 07	32 300 81	2950 MM.	10 pz./box



TERMINALES



ÁREA TÉCNICA • TECHNICAL AREA • DOMAINE TECHNIQUE • TECHNISCHER BEREICH

Design: Ferramol®

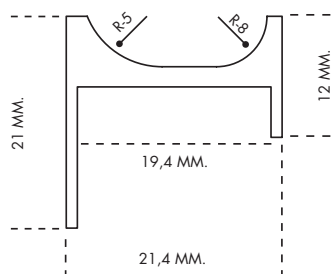

**Ref. 36**  
Material: Aluminium

FINISHES			
07	81	82	L
<i>Cromo mate</i>	<i>Blanco mate</i>	<i>Negro mate</i>	<i>Largo</i>
<i>Matt chrome</i>	<i>Matt white</i>	<i>Matt blk</i>	<i>Lenght</i>
<i>Chrome mat</i>	<i>Blanc mat</i>	<i>Noir mat</i>	<i>Long</i>
<i>Helles chrom</i>	<i>Mattes weiß</i>	<i>Mattes Schwarz</i>	<i>Lang</i>
<b>36 300 07</b>	<b>36 300 81</b>	<b>36 300 82</b>	2950 MM.



10 pz./box

TERMINALS RIGHT				
<b>368 97</b>	<b>368 81</b>	<b>368 82</b>	14 MM.	25 pz./box

TERMINALS LEFT				
<b>369 97</b>	<b>369 81</b>	<b>369 82</b>	14 MM.	25 pz./box



**TERMINALES**



**REF. 378**  
right



**REF. 379**  
left

**ÁREA TÉCNICA • TECHNICAL AREA • DOMAINE TECHNIQUE • TECHNISCHER BEREICH**

Design: Ferramol®

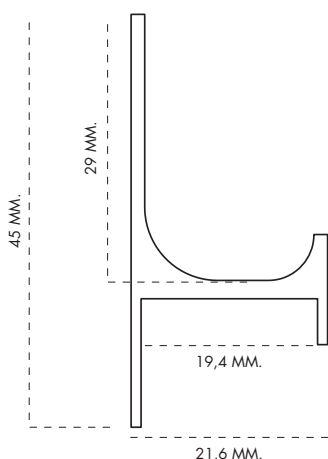

**Ref. 37**  
Material: Aluminium

FINISHES					
07	81	82	L		
<i>Cromo mate</i>	<i>Blanco mate</i>	<i>Negro mate</i>	<i>Largo</i>		
<i>Matt chrome</i>	<i>Matt white</i>	<i>Matt blk</i>	<i>Lenght</i>		
<i>Chrome mat</i>	<i>Blanc mat</i>	<i>Noir mat</i>	<i>Long</i>		
<i>Helles chrom</i>	<i>Mattes weiß</i>	<i>Mattes Schwarz</i>	<i>Lang</i>		
<b>37 030 07</b>	<b>37 030 81</b>	<b>37 030 82</b>	297 MM.		25 pz./box
<b>37 037 07</b>	<b>37 035 81</b>	<b>37 035 82</b>	347 MM.		25 pz./box
<b>37 040 07</b>	<b>37 040 81</b>	<b>37 040 82</b>	397 MM.		25 pz./box
<b>37 045 07</b>	<b>37 045 81</b>	<b>37 045 82</b>	447 MM.		25 pz./box
<b>37 050 07</b>	<b>37 050 81</b>	<b>37 050 82</b>	497 MM.		25 pz./box
<b>37 070 07</b>	<b>37 070 81</b>	<b>37 070 82</b>	597 MM.		25 pz./box
<b>37 070 07</b>	<b>37 070 81</b>	<b>37 070 82</b>	697 MM.		25 pz./box
<b>37 080 07</b>	<b>37 080 81</b>	<b>37 080 82</b>	797 MM.		25 pz./box
<b>37 090 07</b>	<b>37 090 81</b>	<b>37 090 82</b>	897 MM.		25 pz./box
<b>37 100 07</b>	<b>37 100 81</b>	<b>37 100 82</b>	997 MM.		25 pz./box
<b>37 120 07</b>	<b>37 120 81</b>	<b>37 120 82</b>	1197 MM.		25 pz./box
<b>37 300 07</b>	<b>37 300 81</b>	<b>37 300 82</b>	2950 MM.		30 pz./box
TERMINALS RIGHT					
<b>378 97</b>	<b>378 81</b>	<b>378 82</b>	14 MM.		25 pz./box
TERMINALS LEFT					
<b>379 97</b>	<b>379 81</b>	<b>379 82</b>	14 MM.	25 pz./box	





ÁREA TÉCNICA • TECHNICAL AREA • DOMAINE TECHNIQUE • TECHNISCHER BEREICH

Design: Ferramol®

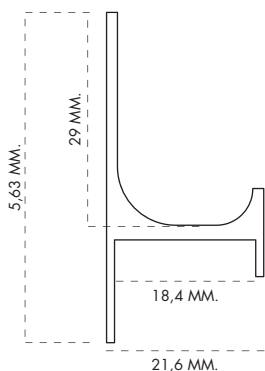

**Ref. 27**  
Aluminio/Aluminium

**FINISHES**

07	L
Cromo mate	Largo
Matt chrome	Lenght
Chrome mat	Long
Helles chrom	Lang



27 300 07      2950 MM.      10 pz./box

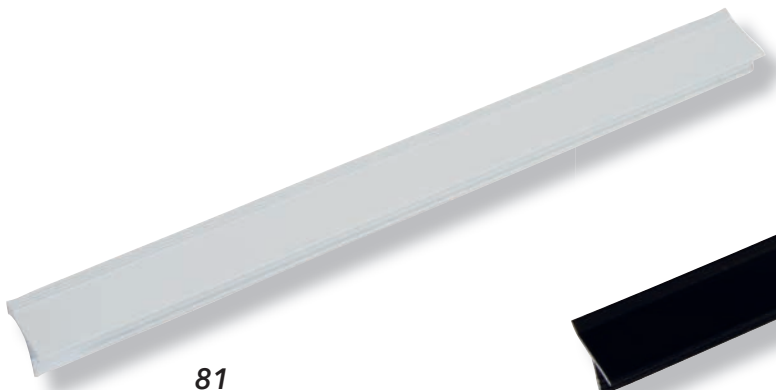

**ÁREA TÉCNICA • TECHNICAL AREA • DOMAINE TECHNIQUE • TECHNISCHER BEREICH**

Design: Ferramol®

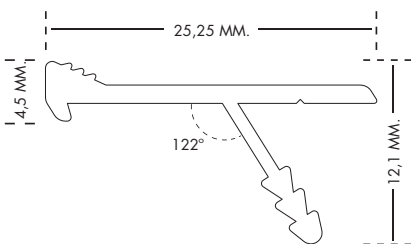

**Ref. 31**  
Material: Aluminium

FINISHES			
07	81	82	L
<i>Cromo mate</i>	<i>Blanco mate</i>	<i>Negro mate</i>	<i>Largo</i>
<i>Matt chrome</i>	<i>Matt white</i>	<i>Matt blk</i>	<i>Lenght</i>
<i>Chrome mat</i>	<i>Blanc mat</i>	<i>Noir mat</i>	<i>Long</i>
<i>Helles chrom</i>	<i>Mattes weiß</i>	<i>Mattes Schwarz</i>	<i>Lang</i>
<b>31 300 07</b>	<b>31 300 81</b>	<b>31 300 82</b>	2950 MM.



10 pz./box





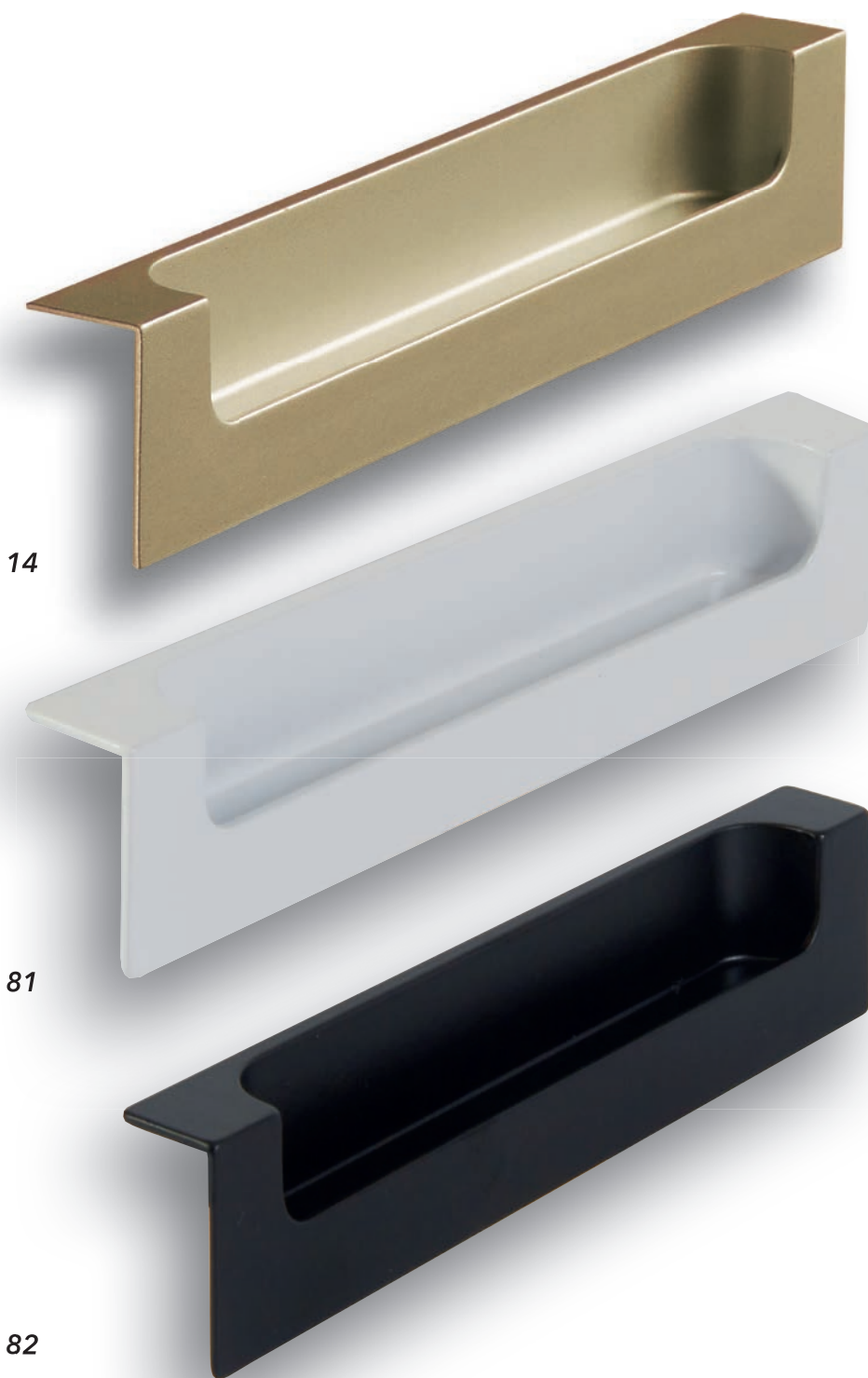

**ÁREA TÉCNICA • TECHNICAL AREA • DOMAINE TECHNIQUE • TECHNISCHER BEREICH**

Design: Ferramol®

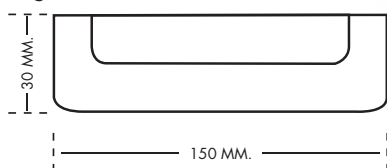

**Ref. 193**  
Material: Aluminium

FINISHES						
14	81	82	97	L	⊙ ⊙	
Oro satinado	Blanco mate	Negro mate	Epoxi cromo mate	Largo	Tornillos	
Satin gold	Matt white	Matt blk	Epoxi Matt chr.	Lenght	Screws	
Or satiné	Blanc mat	Noir mat	Epoxi Chro. mat	Long	Des vis	
Satin gold	Mattes weiß	Mattes Schwarz	Epoxi Helles chr.	Lang	Seiten	
193 128 14	193 128 81	193 128 82	193 128 97	150 MM.	128 MM.	50 pz./box



The handle ref. 63 by Ferramol® is a handle designed for the home. It is modern, ergonomic and very very functional. It is created for all environments: cabinets, kitchens, dressing rooms, etc. The wide variety of sizes facilitates its placement, both in drawers and doors, offering infinite possibilities of use

The handle ref. 63 by Ferramol is a handle designed for the home. It is modern, ergonomic and very very functional. It is created for all environments: cabinets, kitchens, dressing rooms, etc. The wide variety of sizes facilitates its placement, both in drawers and doors, offering infinite possibilities of use

La poignée Ref. 63 de Ferramol® est une poignée conçue pour la maison. Moderne, ergonomique et très fonctionnel. Conçu pour tous les environnements:

armoires, cuisines, dressings, etc.

La grande variété de tailles facilite son placement, tant dans les tiroirs que dans les portes, offrant des possibilités d'utilisation infinies.

Fabriqué en aluminium, il est disponible en plusieurs longueurs.

Disponible en noir mat, en blanc mat et en acier inoxydable. chrome mat.

Der Griff Ref. 63 von Ferramol® ist ein Griff für den Wohnbereich.

Modern, ergonomisch und sehr funktionell.

Er ist für alle Umgebungen geeignet: Schränke, Küchen, Umkleieräume, usw.

Die große Auswahl an Größen ermöglicht eine einfache Anpassung sowohl an Schubladen als auch an Türen und bietet unendliche Einsatzmöglichkeiten.

Er ist aus Aluminium gefertigt und in verschiedenen Längen erhältlich.

Erhältlich in Mattschwarz, Mattweiß und Mattchrom.



El tirador Ref. 63 de Ferramol® es un tirador diseñado para el hogar. Moderno, ergonómico y muy, muy funcional. Creado para todos los ambientes: armarios, cocinas, vestidores, etc. La amplia variedad de medidas facilita su colocación, tanto en cajones, como puertas, ofreciendo infinitas posibilidades de uso.

Fabricado en aluminio, se presenta en varias longitudes. Disponible es negro mate, blanco mate y cromo mate.









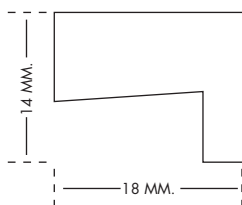

**ÁREA TÉCNICA • TECHNICAL AREA • DOMAINE TECHNIQUE • TECHNISCHER BEREICH**

Design: Ferramol®



**Ref. 63**

Material: Aluminium

FINISHES					
81	82	97	L	 	
<i>Blanco mate</i> <i>Matt white</i> <i>Blanc mat</i> <i>Mattes weiß</i>	<i>Negro mate</i> <i>Matt black</i> <i>Noir mat</i> <i>Mattes schwarz</i>	<i>Epoxi cromo mate</i> <i>Epoxi Matt chr.</i> <i>Epoxi Chro. mat</i> <i>Epoxi Helles chr.</i>	<i>Largo</i> <i>Lenght</i> <i>Long</i> <i>Lang</i>	<i>Tornillos</i> <i>Screws</i> <i>Des vis</i> <i>Seiten</i>	
63 025 81	63 025 82	63 025 97	247 MM.	192 MM.	50 pz./box
---	63 048 82	---	475 MM.	320 MM.	25 pz./box
63 110 81	63 110 82	63 110 97	1097 MM.	1097 MM.	25 pz./box
---	63 140 82	---	1400 MM.	1400 MM.	25 pz./box











82



14

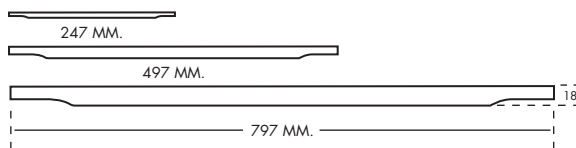

**ÁREA TÉCNICA • TECHNICAL AREA**  
**DOMAINE TECHNIQUE • TECHNISCHER BEREICH**  
 Design: Ferramol®

**Ref. 66**  
 Material: Aluminium

**FINISHES**

14	82	L	⊕ ⊖	
<i>Oro satinado</i> <i>Satin gold</i> <i>Or satiné</i> <i>Satin gold</i>	<i>Negro mate</i> <i>Matt black</i> <i>Noir mat</i> <i>Mattes schwarz</i>	<i>Largo</i> <i>Lenght</i> <i>Long</i> <i>Lang</i>	<i>Tornillos</i> <i>Screws</i> <i>Des vis</i> <i>Seiten</i>	
<b>66 025 14</b>	<b>66 025 82</b>	192 MM.	247 MM.	50 pz./box
<b>66 050 14</b>	<b>66 050 82</b>	320 MM.	497 MM.	25 pz./box
<b>66 080 14</b>	<b>66 080 82</b>	320 MM.	797 MM.	25 pz./box

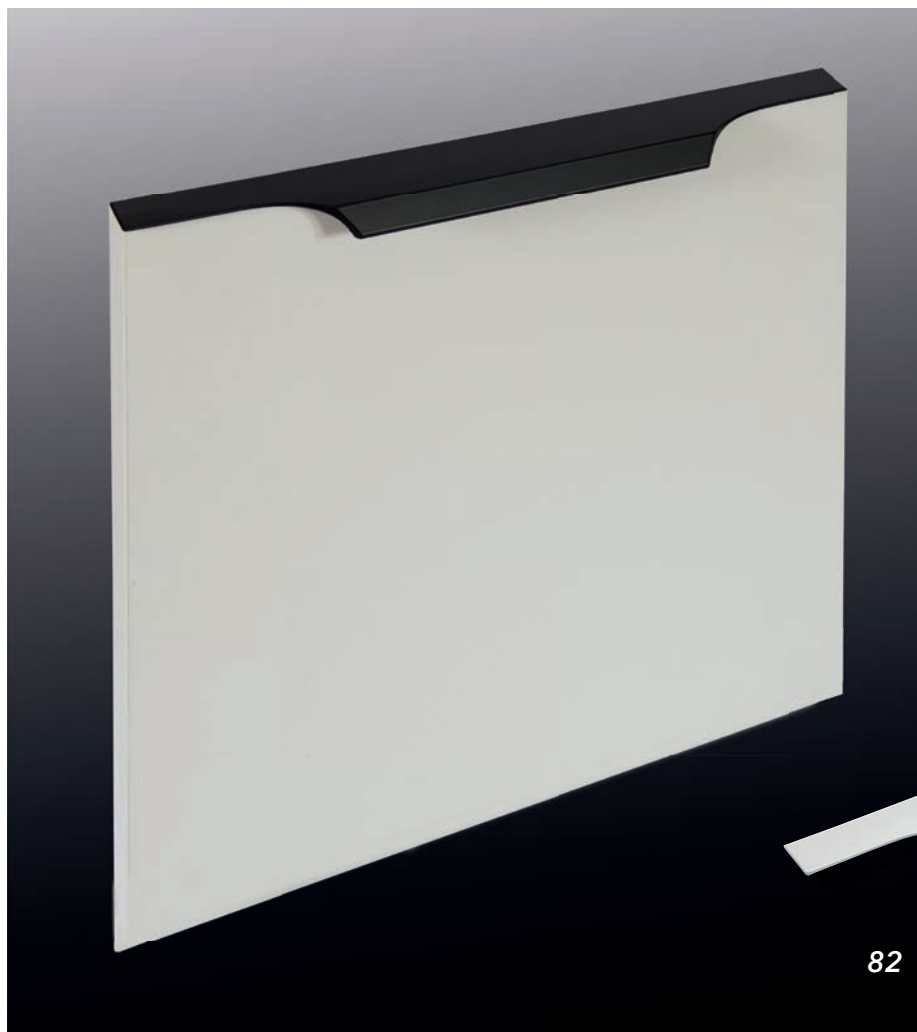

81

Wide 20 mm.

82

ÁREA TÉCNICA • TECHNICAL AREA • DOMAINE TECHNIQUE • TECHNISCHER BEREICH

Design: Ferramol®

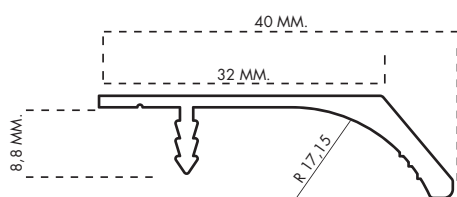

Ref. 60

Material: Aluminium

FINISHES

81	82	L	
Blanco mate Matt white Blanc mat Mattes weiß	Negro mate Matt black Noir mat Mattes schwarz	Largo Lenght Long Lang	
60 015 81	60 015 82	147 MM.	25 pz./box
60 020 81	60 020 82	197 MM.	25 pz./box
60 025 81	60 025 82	247 MM.	25 pz./box
60 030 81	60 030 82	297 MM.	25 pz./box
60 035 81	60 035 82	347 MM.	25 pz./box
60 040 81	60 040 82	397 MM.	25 pz./box
60 045 81	60 045 82	447 MM.	25 pz./box
60 050 81	60 050 82	497 MM.	25 pz./box
60 060 81	60 060 82	597 MM.	25 pz./box
60 070 81	60 070 82	697 MM.	25 pz./box
60 080 81	60 080 82	797 MM.	25 pz./box
60 090 81	60 090 82	897 MM.	25 pz./box
60 100 81	60 100 82	997 MM.	25 pz./box
60 120 81	60 120 82	1197 MM.	25 pz./box
60 300 81	60 300 82	2950 MM.	10 pz./box

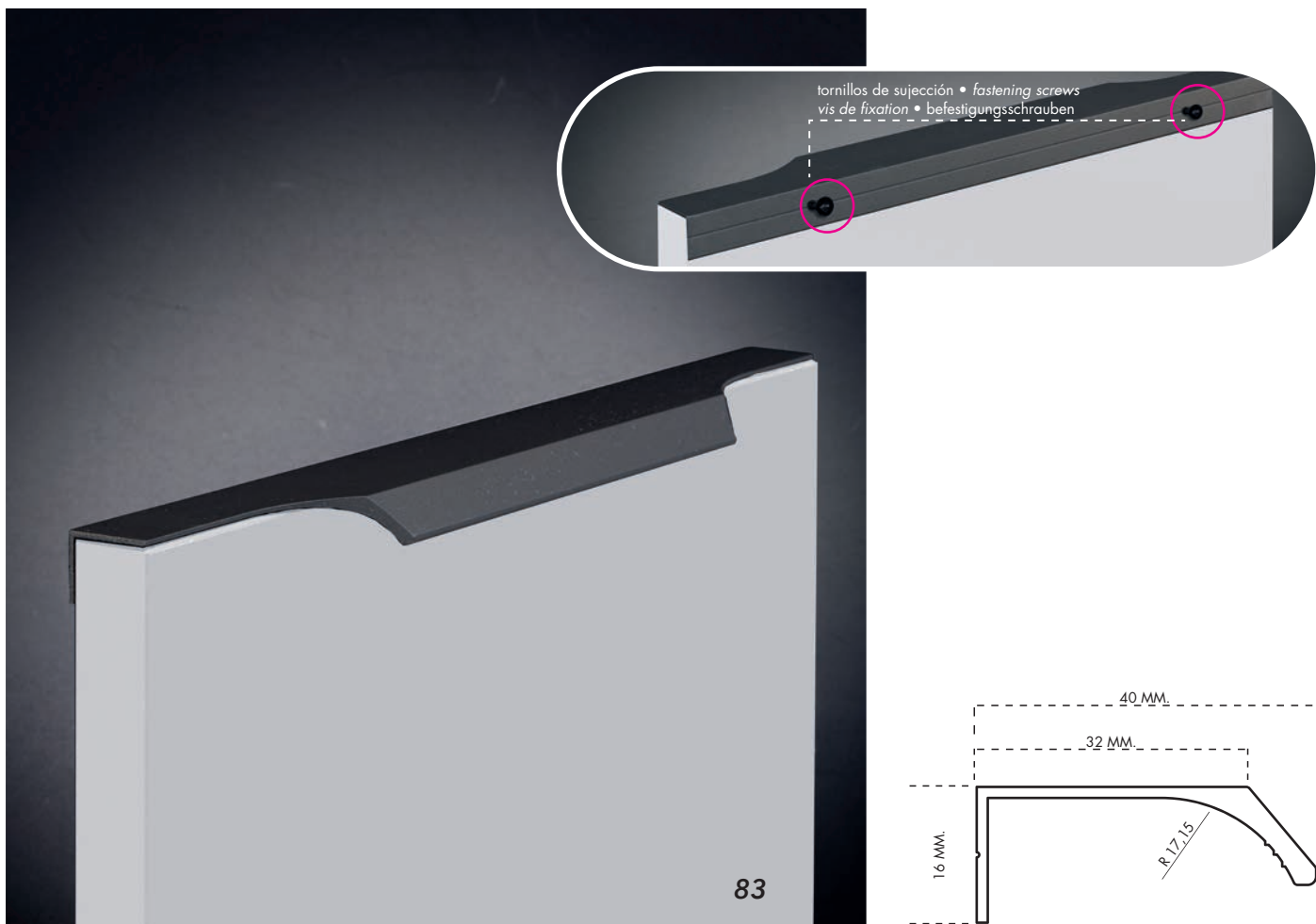

ÁREA TÉCNICA • TECHNICAL AREA • DOMAINE TECHNIQUE • TECHNISCHER BEREICH

Design: Ferramol®

**Ref. 61**  
Material: Aluminium

**FINISHES**

07	81	82	83	L	
<i>Cromo mate</i>	<i>Blanco mate</i>	<i>Negro mate</i>	<i>Antracita</i>	<i>Largo</i>	
<i>Matt chrome</i>	<i>Matt white</i>	<i>Matt black</i>	<i>Anthracite</i>	<i>Lenght</i>	
<i>Chrome mat</i>	<i>Blanc mat</i>	<i>Noir mat</i>	<i>Anthracite</i>	<i>Long</i>	
<i>Helles chrom</i>	<i>Mattes weiß</i>	<i>Mattes schwarz</i>	<i>Anthrazit</i>	<i>Lang</i>	
61 015 07	61 015 81	61 015 82	61 015 83	147 MM.	25 pz./box
61 020 07	61 020 81	61 020 82	61 020 83	197 MM.	25 pz./box
61 025 07	61 025 81	61 025 82	61 025 83	247 MM.	25 pz./box
61 030 07	61 030 81	61 030 82	61 030 83	297 MM.	25 pz./box
61 035 07	61 035 81	61 035 82	61 035 83	347 MM.	25 pz./box
61 040 07	61 040 81	61 040 82	61 040 83	397 MM.	25 pz./box
61 045 07	61 045 81	61 045 82	61 045 83	447 MM.	25 pz./box
61 050 07	61 050 81	61 050 82	61 050 83	497 MM.	25 pz./box
61 061 07	61 061 81	61 061 82	61 061 83	597 MM.	25 pz./box
61 070 07	61 070 81	61 070 82	61 070 83	697 MM.	25 pz./box
61 080 07	61 080 81	61 080 82	61 080 83	797 MM.	25 pz./box
61 090 07	61 090 81	61 090 82	61 090 83	897 MM.	25 pz./box
61 100 07	61 100 81	61 100 82	61 100 83	997 MM.	25 pz./box
61 120 07	61 120 81	61 120 82	61 120 83	1197 MM.	25 pz./box







81



82



08







81



01



07



14

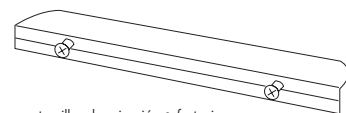
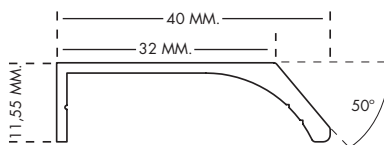



tornillos de sujeción • fastening screws  
vis de fixation • befestigungsschrauben

**ÁREA TÉCNICA • TECHNICAL AREA • DOMAINE TECHNIQUE • TECHNISCHER BEREICH**

Design: Ferramol®

**Ref. 58**  
Material: Aluminium

**FINISHES**

01	07	08	14	81	82	L	  Tornillos Screws Des vis Seiten	
<i>Titanio</i>	<i>Cromo mate</i>	<i>Niquel satinado</i>	<i>Oro satinado</i>	<i>Blanco mate</i>	<i>Negro mate</i>	<i>Largo</i>		
<i>Titanium</i>	<i>Matt chrome</i>	<i>Satin nickel</i>	<i>Satin gold</i>	<i>Matt white</i>	<i>Matt black</i>	<i>Lenght</i>		
<i>Titane</i>	<i>Chrome mat</i>	<i>Nickel satiné</i>	<i>Or satiné</i>	<i>Blanc mat</i>	<i>Noir mat</i>	<i>Long</i>		
<i>Titan</i>	<i>Helles chrom</i>	<i>Satiniertes nickel</i>	<i>Satin gold</i>	<i>Mattes weiß</i>	<i>Mattes schwarz</i>	<i>Lang</i>		
58 010 01	58 010 07	58 010 08	58 010 14	58 010 81	58 010 82	97 MM.	64 MM.	50 pz./box
58 020 01	58 020 07	58 020 08	58 020 14	58 020 81	58 020 82	197 MM.	128 MM.	25 pz./box
---	58 035 07	58 035 08	58 035 14	58 035 81	58 035 82	347 MM.	192 MM.	25 pz./box
---	---	---	---	58 093 81	58 093 82	930 MM.	690 MM.	25 pz./box





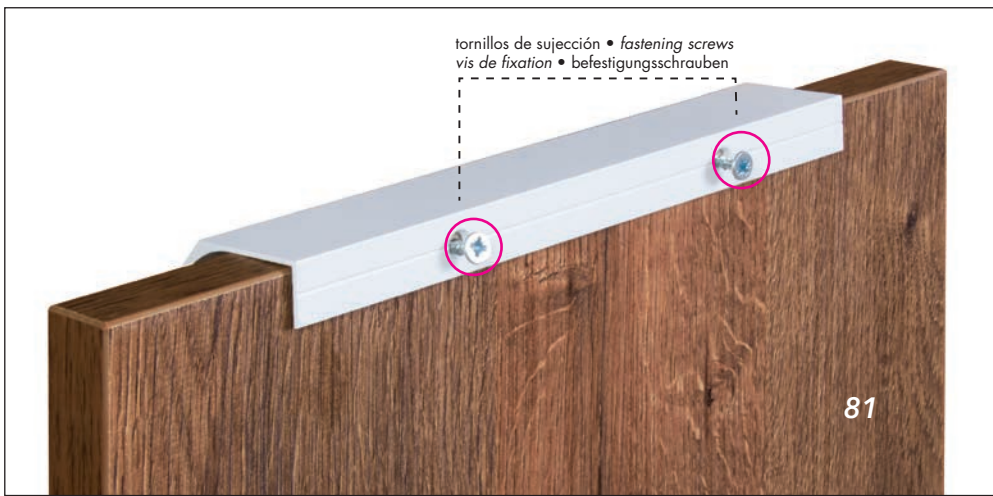



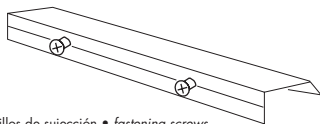
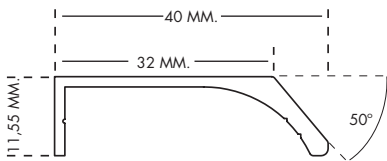

**ÁREA TÉCNICA • TECHNICAL AREA • DOMAINE TECHNIQUE • TECHNISCHER BEREICH**

Design: Ferramol®



tornillos de sujeción • fastening screws  
vis de fixation • befestigungsschrauben

**Ref. 62**  
Material: Aluminium

FINISHES					
07	81	82	L		
<i>Cromo mate</i> <i>Matt chrome</i> <i>Chrome mat</i> <i>Helles chrom</i>	<i>Blanco mate</i> <i>Matt white</i> <i>Blanc mat</i> <i>Mattes weiß</i>	<i>Negro mate</i> <i>Matt black</i> <i>Noir mat</i> <i>Mattes schwarz</i>	<i>Largo</i> <i>Lenght</i> <i>Long</i> <i>Lang</i>	<i>Tornillos</i> <i>Screws</i> <i>Des vis</i> <i>Seiten</i>	
<b>62 010 07</b>	<b>62 010 81</b>	<b>62 010 82</b>	97 MM.	64 MM.	25 pz./box
<b>62 020 07</b>	<b>62 020 81</b>	<b>62 020 82</b>	127 MM.	128 MM.	25 pz./box
<b>62 120 07</b>	<b>62 120 81</b>	<b>62 120 82</b>	1197 MM.	960 MM.	10 pz./box
<b>62 300 07</b>	<b>62 300 81</b>	<b>62 300 82</b>	2950 MM.	---	10 pz./box













82



02



08



07



83

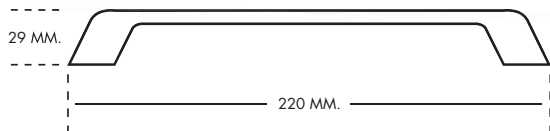

**ÁREA TÉCNICA • TECHNICAL AREA • DOMAINE TECHNIQUE • TECHNISCHER BEREICH**

Design: Ferramol®

Ref. 2775

Material: Zamak

**FINISHES**

02	07	08	81	82	83	L	⊖ ⊕	
<i>Cromo brillo</i>	<i>Cromo mate</i>	<i>Niquel satinado</i>	<i>Blanco mate</i>	<i>Negro mate</i>	<i>Antracita</i>	<i>Largo</i>	<i>Tornillos</i>	
<i>Shine chrome</i>	<i>Matt chrome</i>	<i>Satin nickel</i>	<i>Matt white</i>	<i>Matt black</i>	<i>Anthracite</i>	<i>Lenght</i>	<i>Screws</i>	
<i>Chrome brillant</i>	<i>Chrome mat</i>	<i>Nickel satiné</i>	<i>Blanc mat</i>	<i>Noir mat</i>	<i>Anthracite</i>	<i>Long</i>	<i>Des vis</i>	
<i>Helles chrom</i>	<i>Helles chrom</i>	<i>Satiniertes nickel</i>	<i>Mattes weiß</i>	<i>Mattes schwarz</i>	<i>Anthrazit</i>	<i>Lang</i>	<i>Seiten</i>	
2775 192 02	2775 192 07	2775 192 08	2775 192 81	2775 192 82	2775 192 83	220 MM.	192 MM.	25 pz./box









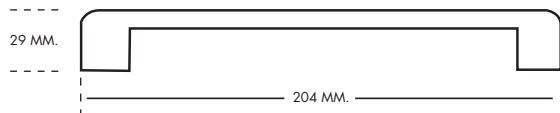

ÁREA TÉCNICA • TECHNICAL AREA • DOMAINE TECHNIQUE • TECHNISCHER BEREICH

Design: Ferramol®



Ref. 2880  
Material: Zamak

FINISHES

02	07	08	13	14	81	82	83	96		
<i>Cromo brillo</i> Shine chrome	<i>Cromo mate</i> Matt chrome	<i>Niquel satinado</i> Satin nickel	<i>Cobre satinado</i> Satin cooper	<i>Oro satinado</i> Satin gold	<i>Blanco mate</i> Matt white	<i>Negro mate</i> Matt black	<i>Antracita</i> Anthracite	<i>Epoxi niqu.</i> Epoxi nick.	<i>Tornillos</i> Screws	
<i>Chrome brillant</i> Helles chrom	<i>Chrome mat</i> Helles chrom	<i>Nickel satiné</i> Satiniertes nickel	<i>Cuivre satiné</i> Satiniertes kupfer	<i>Or satiné</i> Satin gold	<i>Blanc mat</i> Mattes weiß	<i>Noir mat</i> Mattes schwarz	<i>Anthracite</i> Anthrazit	<i>Epoxi nick.</i> Epoxi chor.	<i>Des vis</i> Seiten	
2880 192 02	2880 192 07	2880 192 08	2880 192 13	2880 192 14	---	---	2880 192 83	192 MM.	25 pz./box	
---	---	---	---	---	2880 192 81	2880 192 82	---	2880 192 96	192 MM.	100 pz./box



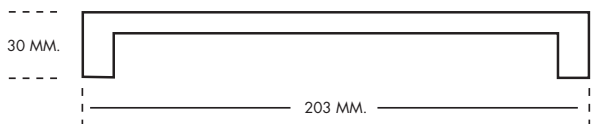
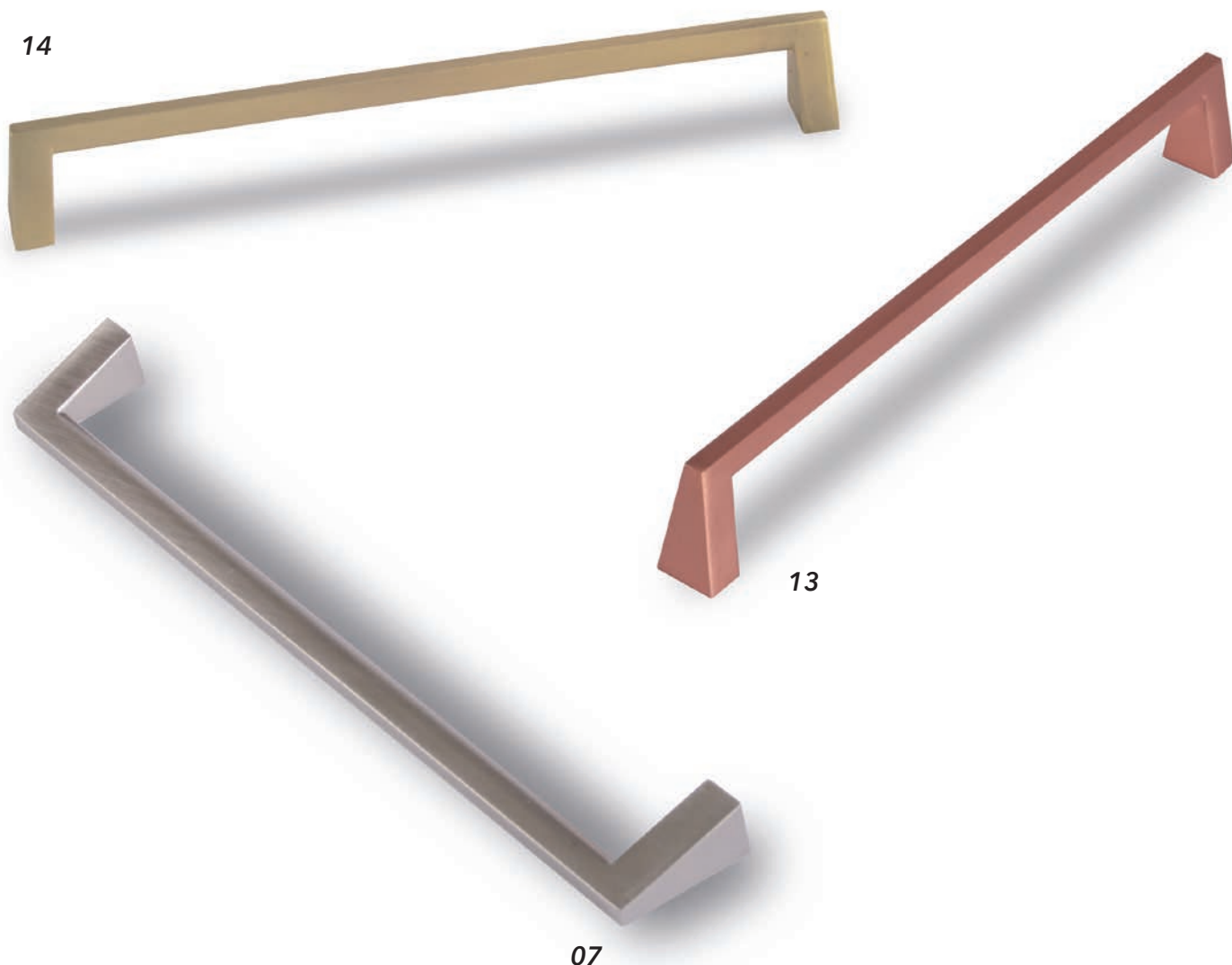

**ÁREA TÉCNICA • TECHNICAL AREA • DOMAINE TECHNIQUE • TECHNISCHER BEREICH**

Design: Ferramol®

**Ref. 2890**

Material: Zamak

**FINISHES**

02	07	08	13	14	L	⊕ ⊖	
<i>Cromo brillo</i> <i>Shine chrome</i> <i>Chrome brillant</i> <i>Helles chrom</i>	<i>Cromo mate</i> <i>Matt chrome</i> <i>Chrome mat</i> <i>Helles chrom</i>	<i>Niquel satinado</i> <i>Satin nickel</i> <i>Nickel satiné</i> <i>Satiniertes nickel</i>	<i>Cobre satinado</i> <i>Satin cooper</i> <i>Cuivre satiné</i> <i>Satiniertes kupfer</i>	<i>Oro satinado</i> <i>Satin gold</i> <i>Or satiné</i> <i>Satin gold</i>	<i>Largo</i> <i>Lenght</i> <i>Long</i> <i>Lang</i>	<i>Tornillos</i> <i>Screws</i> <i>Des vis</i> <i>Seiten</i>	
<b>2890 192 02</b>	<b>2890 192 07</b>	<b>2890 192 08</b>	<b>2890 192 13</b>	<b>2890 192 14</b>	203 MM.	192 MM.	25 pz./box









81



82



83



83



83



08



07



02

## ÁREA TÉCNICA

Design: Ferramol®

Ref. 2800



Material: Zamak

### FINISHES

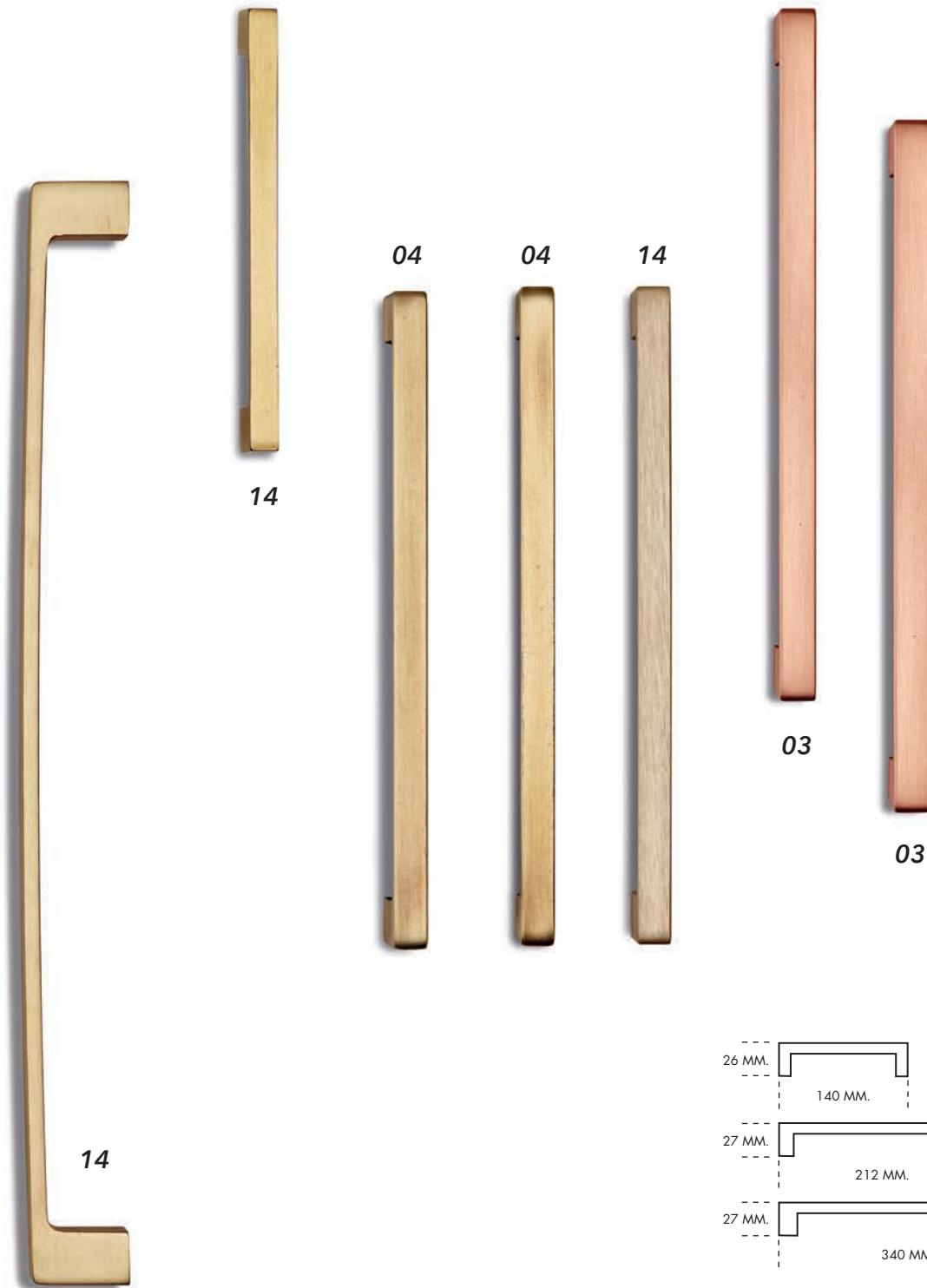
02	03	04
<i>Cromo brillo</i>	<i>Cobre viejo</i>	<i>Oro viejo</i>
<i>Shine chrom.</i>	<i>Old cooper</i>	<i>Old gold</i>
<i>Chr. brillant</i>	<i>Vieux cuivre</i>	<i>Vieux or</i>
<i>Hell. chrom.</i>	<i>Altes kupfer</i>	<i>Altes gold</i>
2800 128 02	2800 128 03	2800 128 04
2800 192 02	2800 192 03	2800 192 04
2800 320 02	2800 320 03	2800 320 04



TECHNICAL AREA • DOMAINE TECHNIQUE • TECHNISCHER BEREICH

FINISHES							
07	08	14	81	82	83	L	 
<i>Cromo mate</i>	<i>Niquel sat.</i>	<i>Oro sat.</i>	<i>Blanco mate</i>	<i>Negro mat</i>	<i>Antracita</i>	<i>Largo</i>	<i>Tornillos</i>
<i>Matt chrome</i>	<i>Satin nickel</i>	<i>Satin gold</i>	<i>Matt white</i>	<i>Matt black</i>	<i>Anthracite</i>	<i>Lenght</i>	<i>Screws</i>
<i>Chrome mat</i>	<i>Nickel sat.</i>	<i>Or satiné</i>	<i>Blanc mat</i>	<i>Noir mat</i>	<i>Anthracite</i>	<i>Long</i>	<i>Des vis</i>
<i>Mattes chro.</i>	<i>Sat. nickel</i>	<i>Satin gold</i>	<i>Mattes weiß</i>	<i>Mat. Schwarz</i>	<i>Anthracite</i>	<i>Lang</i>	<i>Seiten</i>
2800 128 07	2800 128 08	2800 128 14	---	2800 128 82	2800 128 83	140 MM.	128 MM.
2800 192 07	2800 192 08	2800 192 14	2800 192 81	2800 192 82	2800 192 83	212 MM.	192 MM.
2800 320 07	2800 320 08	2800 320 14	---	2800 320 82	2800 320 83	340 MM.	320 MM.
							25 pz./box
							25 pz./box
							25 pz./box





ÁREA TÉCNICA • TECHNICAL AREA • DOMAINE TECHNIQUE • TECHNISCHER BEREICH

Design: Ferramol®

Ref. 2795  
Material: Zamak

FINISHES						
02	03	04	07	L		
<i>Cromo brillo</i> <i>Shine chrome</i> <i>Chrome brillant</i> <i>Helles chrom</i>	<i>Cobre viejo</i> <i>Old cooper</i> <i>Vieux cuivre</i> <i>Altes kupfer</i>	<i>Oro viejo</i> <i>Old gold</i> <i>Vieux or</i> <i>Altes gold</i>	<i>Cromo mate</i> <i>Matt chrome</i> <i>Chrome mat</i> <i>Helles chrom</i>	<i>Largo</i> <i>Lenght</i> <i>Long</i> <i>Lang</i>	<i>Tornillos</i> <i>Screws</i> <i>Des vis</i> <i>Seiten</i>	
2795 128 02	2795 128 03	---	2795 128 07	144 MM.	128 MM.	25 pz./box
2795 192 02	2795 192 03	2795 192 04	2795 192 07	213 MM.	192 MM.	25 pz./box
2795 320 02	2795 320 03	---	2795 320 07	343 MM.	320 MM.	25 pz./box

FINISHES						
08	81	82	83	L		
<i>Niquel satinado</i> <i>Satin nickel</i> <i>Nickel satiné</i> <i>Satiniertes nickel</i>	<i>Blanco mate</i> <i>Matt white</i> <i>Blanc mat</i> <i>Mattes weiß</i>	<i>Negro mate</i> <i>Matt black</i> <i>Noir mat</i> <i>Mattes schwarz</i>	<i>Antracita</i> <i>Anthracite</i> <i>Anthracite</i> <i>Anthrazit</i>	<i>Largo</i> <i>Lenght</i> <i>Long</i> <i>Lang</i>	<i>Tornillos</i> <i>Screws</i> <i>Des vis</i> <i>Seiten</i>	
2795 128 08	---	2795 128 82	2795 128 83	144 MM.	128 MM.	25 pz./box
2795 192 08	2795 192 81	2795 192 82	2795 192 83	213 MM.	192 MM.	25 pz./box
2795 320 08	---	2795 320 82	2795 320 83	343 MM.	320 MM.	25 pz./box

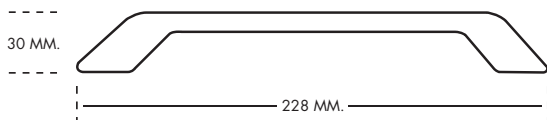
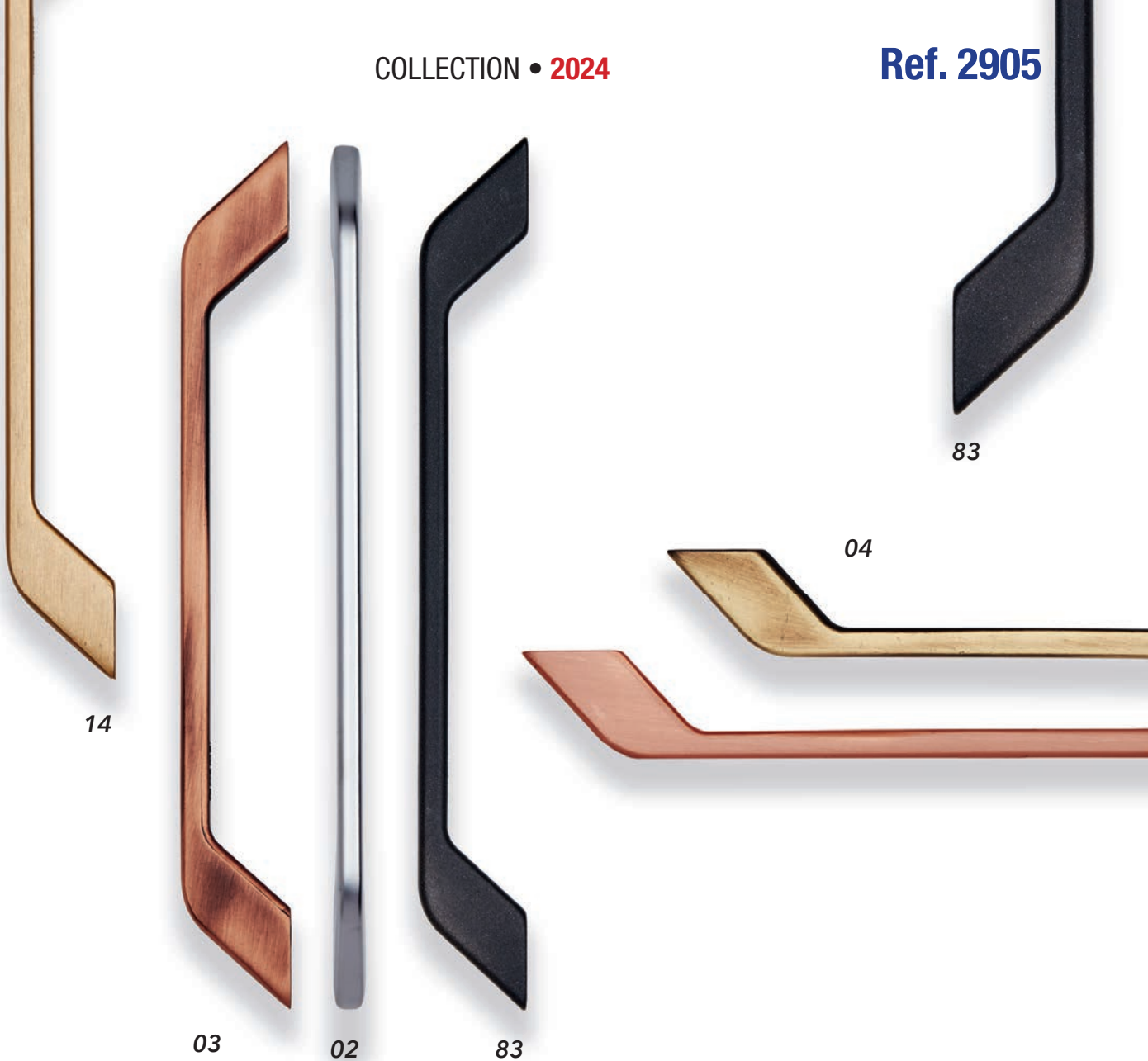

**ÁREA TÉCNICA • TECHNICAL AREA • DOMAINE TECHNIQUE • TECHNISCHER BEREICH**

Design: Ferramol®

**Ref. 2905**  
Material: Zamak

FINISHES						
02	03	04	07	L		
<i>Cromo brillo</i> <i>Shine chrome</i> <i>Chrome brillant</i> <i>Helles chrom</i>	<i>Cobre viejo</i> <i>Old cooper</i> <i>Vieux cuivre</i> <i>Altes kupfer</i>	<i>Oro viejo</i> <i>Old gold</i> <i>Vieux or</i> <i>Altes gold</i>	<i>Cromo mate</i> <i>Matt chrome</i> <i>Chrome mat</i> <i>Helles chrom</i>	<i>Largo</i> <i>Lenght</i> <i>Long</i> <i>Lang</i>	<i>Tornillos</i> <i>Screws</i> <i>Des vis</i> <i>Seiten</i>	
2905 192 02	2905 192 03	2905 192 04	2905 192 07	144 MM.	128 MM.	25 pz./box

FINISHES						
08	14	83	L			
<i>Niquel satinado</i> <i>Satin nickel</i> <i>Nickel satiné</i> <i>Satiniertes nickel</i>	<i>Oro satinado</i> <i>Satin gold</i> <i>Or satiné</i> <i>Satin gold</i>	<i>Antracita</i> <i>Anthracite</i> <i>Anthracite</i> <i>Anthrazit</i>	<i>Largo</i> <i>Lenght</i> <i>Long</i> <i>Lang</i>	<i>Tornillos</i> <i>Screws</i> <i>Des vis</i> <i>Seiten</i>		
2905 192 08	2905 192 14	2905 192 83	144 MM.	128 MM.	25 pz./box	



ÁREA TÉCNICA • TECHNICAL AREA • DOMAINE TECHNIQUE • TECHNISCHER BEREICH

Design: Ferramol®

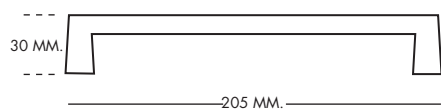

Ref. 2900  
Material: Zamak

FINISHES					
02	07	08	L	Tornillos Screws Des vis Seiten	
<i>Cromo brillo</i> <i>Shine chrome</i> <i>Chrome brillant</i> <i>Helles chrom</i>	<i>Cromo mate</i> <i>Matt chrome</i> <i>Chrome mat</i> <i>Helles chrom</i>	<i>Niquel satinado</i> <i>Satin nickel</i> <i>Nickel satiné</i> <i>Satiniertes nickel</i>	<i>Largo</i> <i>Lenght</i> <i>Long</i> <i>Lang</i>		
2900 192 02	2900 192 07	2900 192 08	205 MM.	192 MM.	25 pz./box



ÁREA TÉCNICA • TECHNICAL AREA • DOMAINE TECHNIQUE • TECHNISCHER BEREICH

Design: Ferramol®

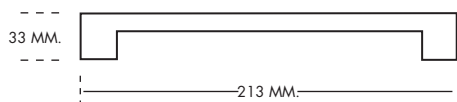

Ref. 2895  
Material: Zamak

FINISHES					
<b>02</b>	<b>07</b>	<b>08</b>	<b>L</b>		
<i>Cromo brillo</i> <i>Shine chrome</i> <i>Chrome brillant</i> <i>Helles chrom</i>	<i>Cromo mate</i> <i>Matt chrome</i> <i>Chrome mat</i> <i>Helles chrom</i>	<i>Niquel satinado</i> <i>Satin nickel</i> <i>Nickel satiné</i> <i>Satiniertes nickel</i>	<i>Largo</i> <i>Lenght</i> <i>Long</i> <i>Lang</i>	<i>Tornillos</i> <i>Screws</i> <i>Des vis</i> <i>Seiten</i>	
2895 192 02	2895 192 07	2895 192 08	213 MM.	192 MM.	25 pz./box





82



02



81

106



**ÁREA TÉCNICA • TECHNICAL AREA • DOMAINE TECHNIQUE • TECHNISCHER BEREICH**

Design: Ferramol®

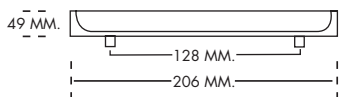

**Ref. 2860**  
Material: Zamak

FINISHES						
02	81	82	97	L	⊖ ⊖	
<i>Cromo brillo</i> Shine chrome Chrome brillant Helles chrom	<i>Blanco mate</i> Matt white Blanc mat Mattes weiß	<i>Negro mate</i> Matt black Noir mat Mattes schwarz	<i>Epoxi cromo mate</i> Epoxi Matt chr. Epoxi Chro. mat Epoxi Helles chr.	<i>Largo</i> Lenght Long Lang	<i>Tornillos</i> Screws Des vis Seiten	
2860 128 02	2860 128 81	2860 128 82	2860 128 97	206 MM.	128 MM.	25 pz./box



02



02



08



07

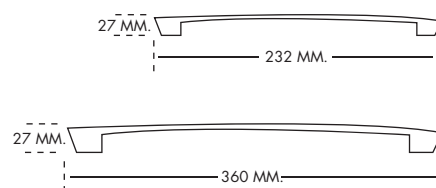

**ÁREA TÉCNICA**



**TECHNICAL AREA • DOMAINE TECHNIQUE • TECHNISCHER BEREICH**

Design: Ferramol®

Ref. 2850

Material: Zamak

**FINISHES**

02	07	08	L	 	
Cromo brillo Shine chrome Chrome brillant Helles chrom	Cromo mate Matt chrome Chrome mat Helles chrom	Niquel satinado Satin nickel Nickel satiné Satiniertes nickel	Largo Lenght Long Lang	Tornillos Screws Des vis Seiten	
2900 192 02	2900 192 07	2900 192 08	232 MM.	192 MM.	25 pz./box
2900 320 02	2900 320 07	2900 320 08	360 MM.	320 MM.	25 pz./box



07



08



83



02

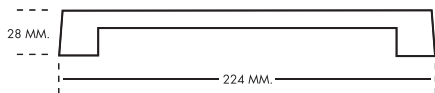

ÁREA TÉCNICA • TECHNICAL AREA • DOMAINE TECHNIQUE • TECHNISCHER BEREICH

Design: Ferramol®

Ref. 2885  
Material: Zamak

FINISHES

02	07	08	83	L	⊕ ⊖	
<i>Cromo brillo</i>	<i>Cromo mate</i>	<i>Niquel satinado</i>	<i>Antracita</i>	<i>Largo</i>	<i>Tornillos</i>	
<i>Shine chrome</i>	<i>Matt chrome</i>	<i>Satin nickel</i>	<i>Anthracite</i>	<i>Length</i>	<i>Screws</i>	
<i>Chrome brillant</i>	<i>Chrome mat</i>	<i>Nickel satiné</i>	<i>Anthracite</i>	<i>Long</i>	<i>Des vis</i>	
<i>Helles chrom</i>	<i>Helles chrom</i>	<i>Satiniertes nickel</i>	<i>Anthrazit</i>	<i>Lang</i>	<i>Seiten</i>	
2885 192 02	2885 192 07	2885 192 08	2885 192 83	224 MM.	192 MM.	25 pz./box





ÁREA TÉCNICA • TECHNICAL AREA • DOMAINE TECHNIQUE • TECHNISCHER BEREICH

Design: Ferramol®

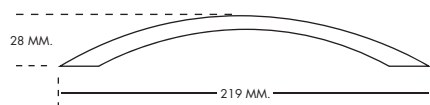

Ref. 2845  
Material: Zamak

FINISHES					
02	07	08	L		
<i>Cromo brillo</i>	<i>Cromo mate</i>	<i>Niquel satinado</i>	<i>Largo</i>		
<i>Shine chrome</i>	<i>Matt chrome</i>	<i>Satin nickel</i>	<i>Lenght</i>		
<i>Chrome brillant</i>	<i>Chrome mat</i>	<i>Nickel satiné</i>	<i>Long</i>		
<i>Helles chrom</i>	<i>Helles chrom</i>	<i>Satiniertes nickel</i>	<i>Lang</i>		
2845 192 02	2845 192 07	2845 192 08	219 MM.	192 MM.	25 pz./box



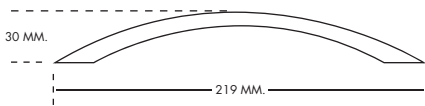

**ÁREA TÉCNICA • TECHNICAL AREA • DOMAINE TECHNIQUE • TECHNISCHER BEREICH**

Design: Ferramol®

**Ref. 2840**  
Material: Zamak

FINISHES						
02	07	08	83	L	⊖ ⊕	
<i>Cromo brillo</i> <i>Shine chrome</i> <i>Chrome brillant</i> <i>Helles chrom</i>	<i>Cromo mate</i> <i>Matt chrome</i> <i>Chrome mat</i> <i>Helles chrom</i>	<i>Niquel satinado</i> <i>Satin nickel</i> <i>Nickel satiné</i> <i>Satiniertes nickel</i>	<i>Antracita</i> <i>Anthracite</i> <i>Anthracite</i> <i>Anthrazit</i>	<i>Largo</i> <i>Lenght</i> <i>Long</i> <i>Lang</i>	<i>Tornillos</i> <i>Screws</i> <i>Des vis</i> <i>Seiten</i>	
2840 192 02	2840 192 07	2840 192 08	2840 192 83	219 MM.	192 MM.	25 pz./box



02



08



08

ÁREA TÉCNICA • TECHNICAL AREA • DOMAINE TECHNIQUE • TECHNISCHER BEREICH

Design: Ferramol®

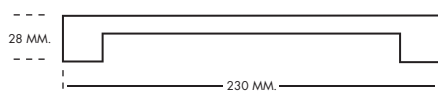

Ref. 2835  
Material: Zamak

FINISHES				
02	07	08	L	⊕ ⊖
<i>Cromo brillo</i> <i>Shine chrome</i> <i>Chrome brillant</i> <i>Helles chrom</i>	<i>Cromo mate</i> <i>Matt chrome</i> <i>Chrome mat</i> <i>Helles chrom</i>	<i>Niquel satinado</i> <i>Satin nickel</i> <i>Nickel satiné</i> <i>Satiniertes nickel</i>	<i>Largo</i> <i>Lenght</i> <i>Long</i> <i>Lang</i>	<i>Tornillos</i> <i>Screws</i> <i>Des vis</i> <i>Seiten</i>
2835 192 02	2835 192 07	2835 192 08	230 MM.	25 pz./box





08



02



07

ÁREA TÉCNICA • TECHNICAL AREA • DOMAINE TECHNIQUE • TECHNISCHER BEREICH

Design: Ferramol®



Ref. 2830  
Material: Zamak

FINISHES					
02	07	08	L	⊕ ⊖	
<i>Cromo brillo</i> <i>Shine chrome</i> <i>Chrome brillant</i> <i>Helles chrom</i>	<i>Cromo mate</i> <i>Matt chrome</i> <i>Chrome mat</i> <i>Helles chrom</i>	<i>Niquel satinado</i> <i>Satin nickel</i> <i>Nickel satiné</i> <i>Satiniertes nickel</i>	<i>Largo</i> <i>Lenght</i> <i>Long</i> <i>Lang</i>	<i>Tornillos</i> <i>Screws</i> <i>Des vis</i> <i>Seiten</i>	
2830 192 02	2830 192 07	2830 192 08	233 MM.	192 MM.	25 pz./box



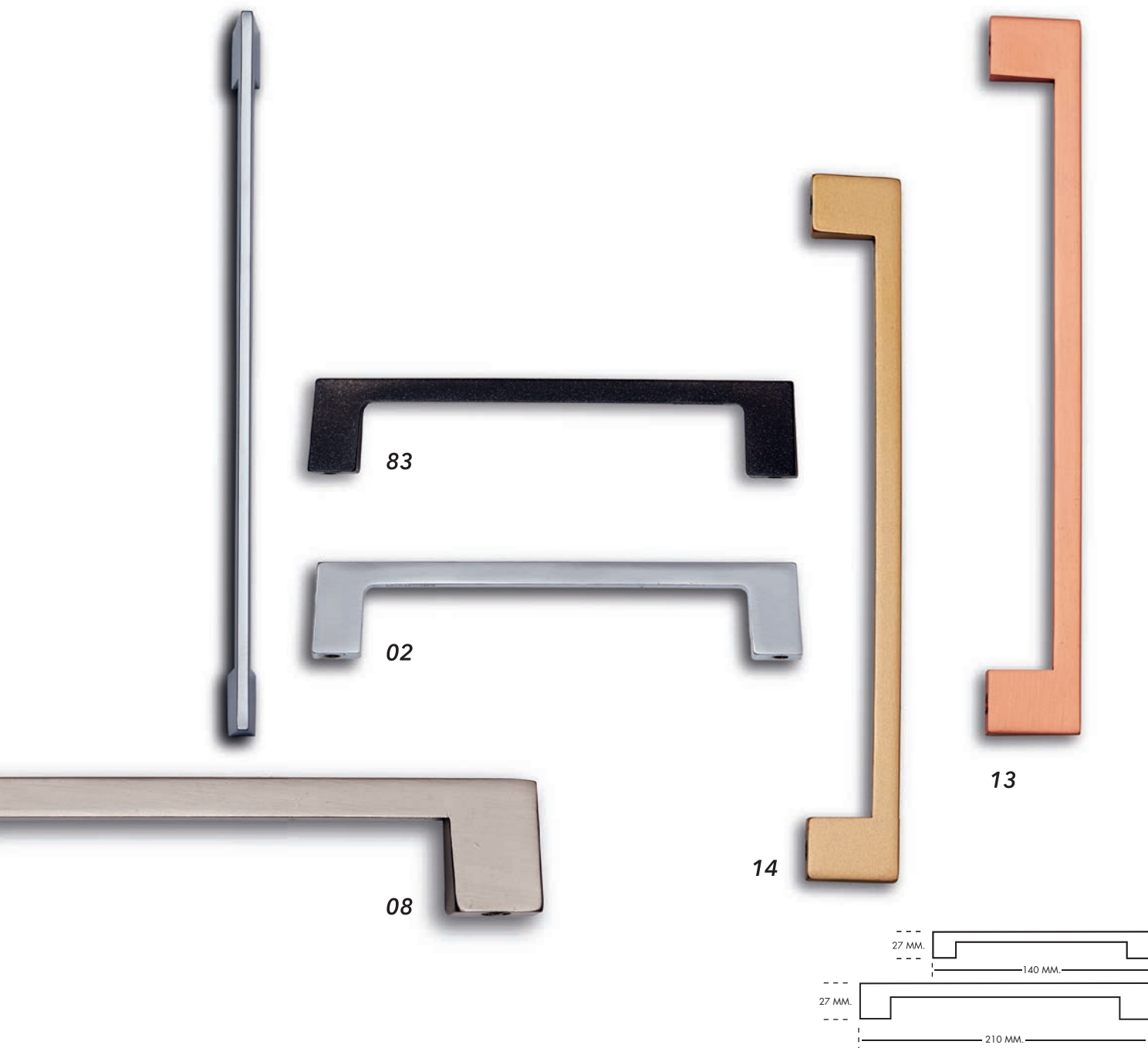





ÁREA TÉCNICA • TECHNICAL AREA • DOMAINE TECHNIQUE • TECHNISCHER BEREICH

Design: Ferramol®

Ref. 2825

Material: Zamak

FINISHES

02	07	08	13	14	83	L			
<i>Cromo brillo</i> Shine chrome Chrome brillant Helles chrom	<i>Cromo mate</i> Matt chrome Chrome mat Helles chrom	<i>Niquel satinado</i> Satin nickel Nickel satiné Satiniertes nickel	<i>Cobre satinado</i> Satin cooper Cuivre satiné Satin. kupfer	<i>Oro satinado</i> Satin gold Or satiné Satin gold	<i>Antracita</i> Anthracite Anthracite Anthrazit	<i>Largo</i> Lenght Long Lang			
2825 128 02	2825 128 07	2825 128 08	---	---	2825 128 83	140 MM.	128 MM.		25 pz./box
2825 192 02	2825 192 07	2825 192 08	2825 192 13	2825 192 14	2825 192 83	210 MM.	192 MM.		25 pz./box



83

08

07

02

83

ÁREA TÉCNICA • TECHNICAL AREA • DOMAINE TECHNIQUE • TECHNISCHER BEREICH

Design: Ferramol®

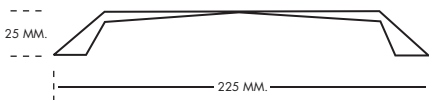

Ref. 2820  
Material: Zamak

FINISHES

02	07	08	83	L	⊕ ⊖	
<i>Cromo brillo</i>	<i>Cromo mate</i>	<i>Niquel satinado</i>	<i>Antracita</i>	<i>Largo</i>	<i>Tornillos</i>	
<i>Shine chrome</i>	<i>Matt chrome</i>	<i>Satin nickel</i>	<i>Anthracite</i>	<i>Lenght</i>	<i>Screws</i>	
<i>Chrome brillant</i>	<i>Chrome mat</i>	<i>Nickel satiné</i>	<i>Anthracite</i>	<i>Long</i>	<i>Des vis</i>	
<i>Helles chrom</i>	<i>Helles chrom</i>	<i>Satiniertes nickel</i>	<i>Anthrazit</i>	<i>Lang</i>	<i>Seiten</i>	
2820 192 02	2820 192 07	2820 192 08	2820 192 83	225 MM.	192 MM.	25 pz./box



**ÁREA TÉCNICA • TECHNICAL AREA • DOMAINE TECHNIQUE • TECHNISCHER BEREICH**

Design: Ferramol®

**Ref. 2815**

Material: Zamak

**FINISHES**



02	07	08	81	82	96	L	 Tornillos Screws Des vis Seiten	
<i>Cromo brillo</i> Shine chrome Chrome brillant Helles chrom	<i>Cromo mate</i> Matt chrome Chrome mat Helles chrom	<i>Niquel satinado</i> Satin nickel Nickel satiné Satinierteres nickel	<i>Blanco mate</i> Matt white Blanc mat Mattes weiß	<i>Negro mate</i> Matt black Noir mat Mattes schwarz	<i>Epoxi niquel mate</i> Epoxi matt nickel Epoxi nickel satiné Epoxi satin. nickel	Largo Lenght Long Lang		
2815 128 02	2815 128 07	2815 128 08	2815 128 81	2815 128 82	---	150 MM.	128 MM.	25 pz./box
2815 192 02	2815 192 07	2815 192 08	---	---	---	218 MM.	192 MM.	25 pz./box
---	---	---	2815 192 81	2815 192 82	2815 192 96	218 MM.	192 MM.	100 pz./box



**ÁREA TÉCNICA • TECHNICAL AREA • DOMAINE TECHNIQUE • TECHNISCHER BEREICH**

Design: Ferramol®

**Ref. 2810**  
Material: Zamak

FINISHES					
02	07	08	L		
<i>Cromo brillo</i> <i>Shine chrome</i> <i>Chrome brillant</i> <i>Helles chrom</i>	<i>Cromo mate</i> <i>Matt chrome</i> <i>Chrome mat</i> <i>Helles chrom</i>	<i>Niquel satinado</i> <i>Satin nickel</i> <i>Nickel satiné</i> <i>Satiniertes nickel</i>	<i>Largo</i> <i>Lenght</i> <i>Long</i> <i>Lang</i>	<i>Tornillos</i> <i>Screws</i> <i>Des vis</i> <i>Seiten</i>	
2810 192 02	2810 192 07	2810 192 08	233 MM.	192 MM.	25 pz./box



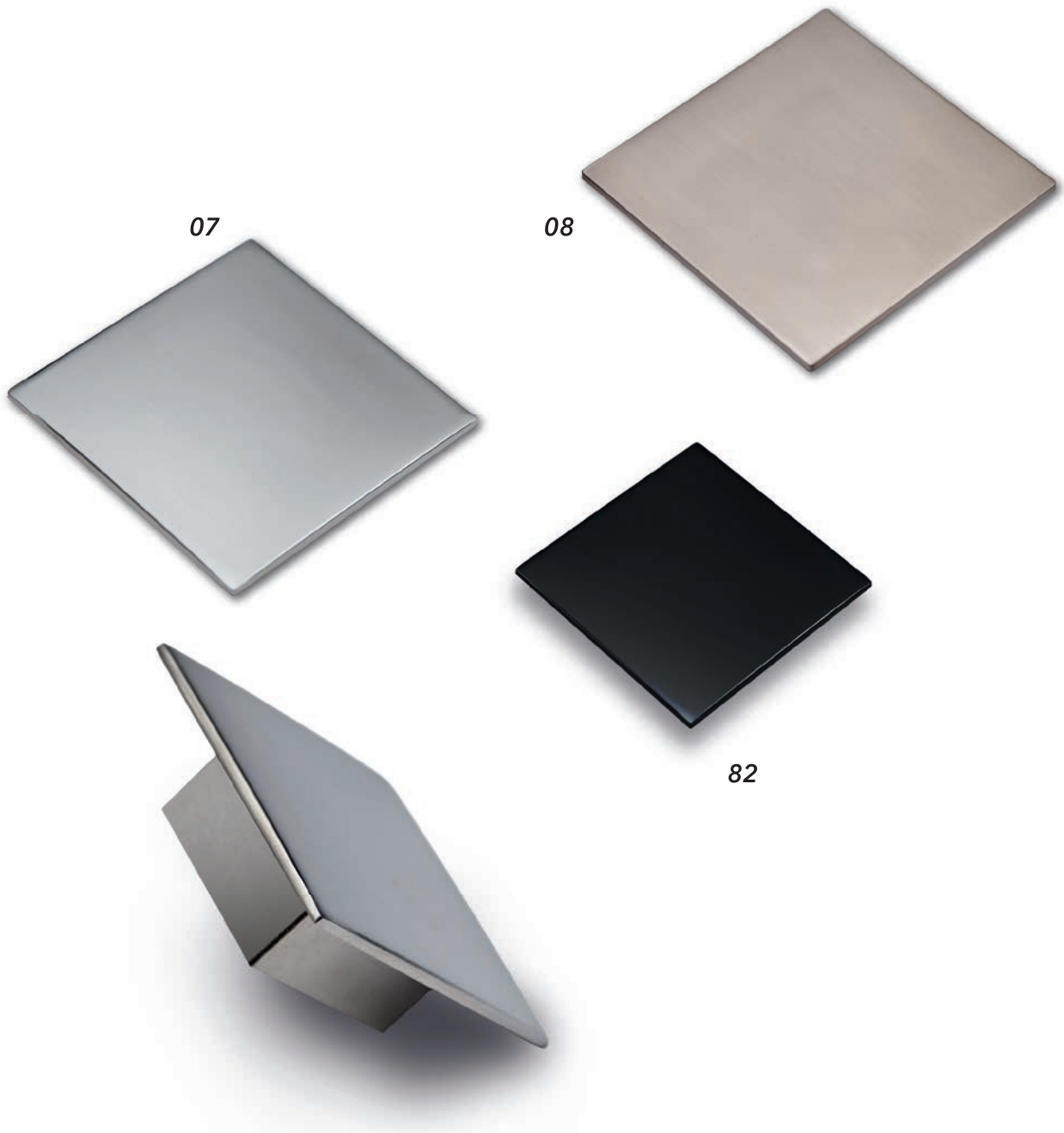

ÁREA TÉCNICA • TECHNICAL AREA • DOMAINE TECHNIQUE • TECHNISCHER BEREICH

Design: Ferramol®

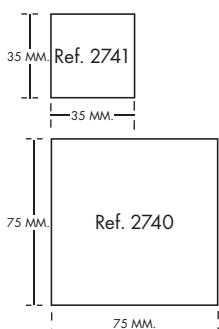

Ref. 2740 • 2741

Material: Zamak

FINISHES						
02	07	08	82	L	⊕ ⊖	⊕ ⊖
<i>Cromo brillo</i> <i>Shine chrome</i> <i>Chrome brillant</i> <i>Helles chrom</i>	<i>Cromo mate</i> <i>Matt chrome</i> <i>Chrome mat</i> <i>Helles chrom</i>	<i>Niquel satinado</i> <i>Satin nickel</i> <i>Nickel satiné</i> <i>Satiniertes nickel</i>	<i>Negro mate</i> <i>Matt black</i> <i>Noir mat</i> <i>Mattes schwarz</i>	<i>Largo</i> <i>Lenght</i> <i>Long</i> <i>Lang</i>	<i>Tornillos</i> <i>Screws</i> <i>Des vis</i> <i>Seiten</i>	
2740 02	2740 07	2740 08	2740 82	75 MM.	32 MM.	50 pz./box
2741 02	2741 07	2741 08	2741 82	35 MM.	---	50 pz./box

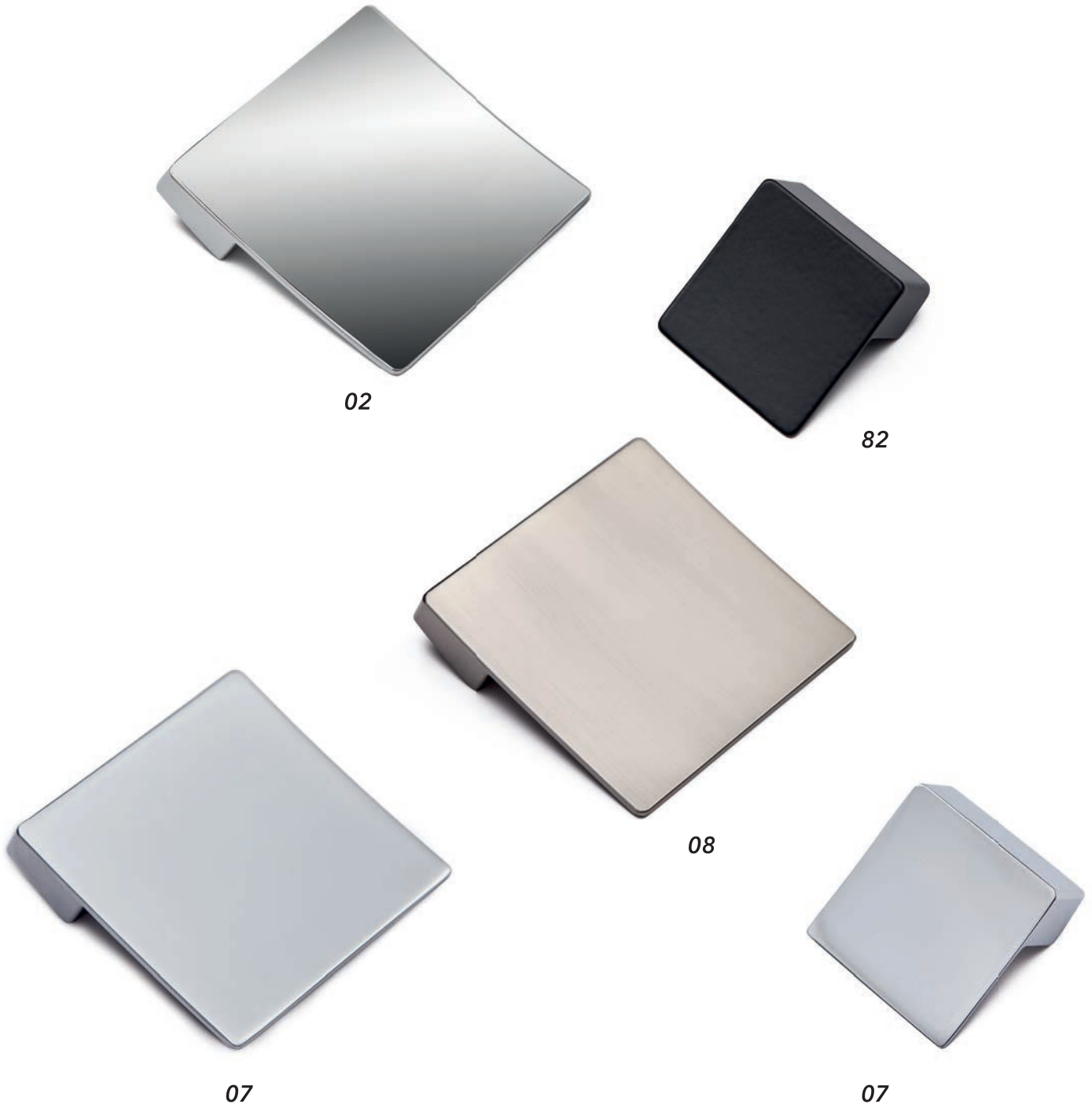

ÁREA TÉCNICA • TECHNICAL AREA • DOMAINE TECHNIQUE • TECHNISCHER BEREICH

Design: Ferramol®

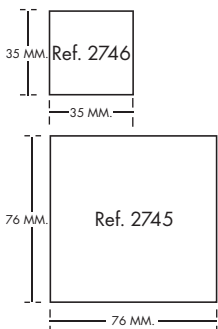

Ref. 2745 • 2746  
Material: Zamak

FINISHES						
02	07	08	82	L	⊕ ⊖	
<i>Cromo brillo</i> <i>Shine chrome</i> <i>Chrome brillant</i> <i>Helles chrom</i>	<i>Cromo mate</i> <i>Matt chrome</i> <i>Chrome mat</i> <i>Helles chrom</i>	<i>Niquel satinado</i> <i>Satin nickel</i> <i>Nickel satiné</i> <i>Satiniertes nickel</i>	<i>Negro mate</i> <i>Matt black</i> <i>Noir mat</i> <i>Mattes schwarz</i>	<i>Largo</i> <i>Lenght</i> <i>Long</i> <i>Lang</i>	<i>Tornillos</i> <i>Screws</i> <i>Des vis</i> <i>Seiten</i>	
2745 02	2745 07	2745 08	2745 82	76 MM.	64 MM.	50 pz./box
2746 02	2746 07	2746 08	2746 82	35 MM.	---	50 pz./box



ÁREA TÉCNICA • TECHNICAL AREA • DOMAINE TECHNIQUE • TECHNISCHER BEREICH

Design: Ferramol®

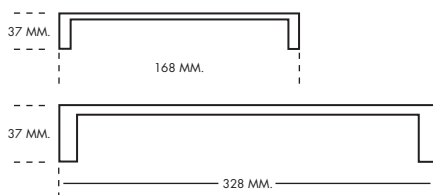

Ref. 6220 • 6240

Material: Zamak

FINISHES			
08	L	⊕ ⊖	
Niquel satinado	Largo	Tornillos	
Satin nickel	Lenght	Screws	
Nickel satiné	Long	Des vis	
Satiniertes nickel	Lang	Seiten	
6220 08	168 MM.	160 MM.	50 pz./box
6240 08	328 MM.	320 MM.	50 pz./box



ÁREA TÉCNICA • TECHNICAL AREA • DOMAINE TECHNIQUE • TECHNISCHER BEREICH

Design: Ferramol®

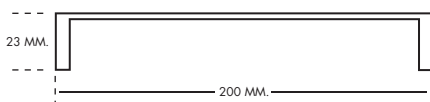

**Ref. 2785**  
Material: Zamak

FINISHES				
07	08	L	⊕ ⊖	
<i>Cromo mate</i>	<i>Niquel satinado</i>	<i>Largo</i>	<i>Tornillos</i>	
<i>Matt chrome</i>	<i>Satin nickel</i>	<i>Lenght</i>	<i>Screws</i>	
<i>Chrome mat</i>	<i>Nickel satiné</i>	<i>Long</i>	<i>Des vis</i>	
<i>Helles chrom</i>	<i>Satiniertes nickel</i>	<i>Lang</i>	<i>Seiten</i>	
<b>2785 192 07</b>	<b>2785 192 08</b>	200 MM.	192 MM.	25 pz./box







ÁREA TÉCNICA • TECHNICAL AREA • DOMAINE TECHNIQUE • TECHNISCHER BEREICH

Design: Ferramol®



**Ref. 65**  
Material: Zamak

**FINISHES**

<b>07</b>	<b>L</b>	 	
<i>Cromo mate</i>	<i>Largo</i>	<i>Tornillos</i>	
<i>Matt chrome</i>	<i>Lenght</i>	<i>Screws</i>	
<i>Chrome mat</i>	<i>Long</i>	<i>Des vis</i>	
<i>Helles chrom</i>	<i>Lang</i>	<i>Seiten</i>	
<b>65 016 07</b>	160 MM.	64 MM.	50 pz./box
<b>65 025 07</b>	250 MM.	224 MM.	50 pz./box









ÁREA TÉCNICA • TECHNICAL AREA • DOMAINE TECHNIQUE • TECHNISCHER BEREICH

Design: Ferramol®



Ref. 65  
Material: Zamak

FINISHES

07	L	⊖ ⊖	
Cromo mate	Largo	Tornillos	
Matt chrome	Lenght	Screws	
Chrome mat	Long	Des vis	
Helles chrom	Lang	Seiten	
67 136 07	136 MM.	64 MM.	50 pz./box
67 400 07	400 MM.	320 MM.	50 pz./box







82



94



95

ÁREA TÉCNICA • TECHNICAL AREA • DOMAINE TECHNIQUE • TECHNISCHER BEREICH

Design: Ferramol®

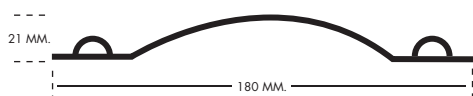

Ref. 2707  
Material: Zamak

FINISHES					
82	94	95	L	⊖ ⊖	
Negro mate Matt black Noir mat Mattes schwarz	Oro viejo rústico Rustic old gold Rustic vieux or Rustikales alt-gold	Plata vieja rústica Rustic old silver Rustic vieux arg. Rustikales alt-silv.	Largo Lenght Long Lang	Tornillos Screws Des vis Seiten	
2707 160 82	2707 160 94	2707 160 95	180 MM.	160 MM.	25 pz./box







95



82



94



95

ÁREA TÉCNICA • TECHNICAL AREA • DOMAINE TECHNIQUE • TECHNISCHER BEREICH

Design: Ferramol®

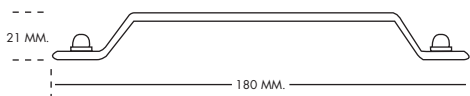

Ref. 2706  
Material: Zamak

FINISHES					
82	94	95	L	⊙	⊙
Negro mate Matt black Noir mat Mattes schwarz	Oro viejo rústico Rustic old gold Rustic vieux or Rustikales alt-gold	Plata vieja rústica Rustic old silver Rustic vieux arg. Rustikales alt-silv.	Largo Lenght Long Lang	Tornillos Screws Des vis Seiten	
2706 160 82	2706 160 94	2706 160 95	181 MM.	160 MM.	25 pz./box







94



94



95



82

ÁREA TÉCNICA • TECHNICAL AREA • DOMAINE TECHNIQUE • TECHNISCHER BEREICH

Design: Ferramol®

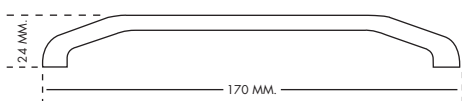

Ref. 2708  
Material: Zamak

FINISHES				
82	94	95	L	⊕ ⊖
Negro mate Matt black Noir mat Mattes schwarz	Oro viejo rústico Rustic old gold Rustic vieux or Rustikales alt-gold	Plata vieja rústica Rustic old silver Rustic vieux arg. Rustikales alt-silv.	Largo Lenght Long Lang	Tornillos Screws Des vis Seiten
2708 160 82	2708 160 94	2708 160 95	170 MM.	160 MM. 25 pz./box



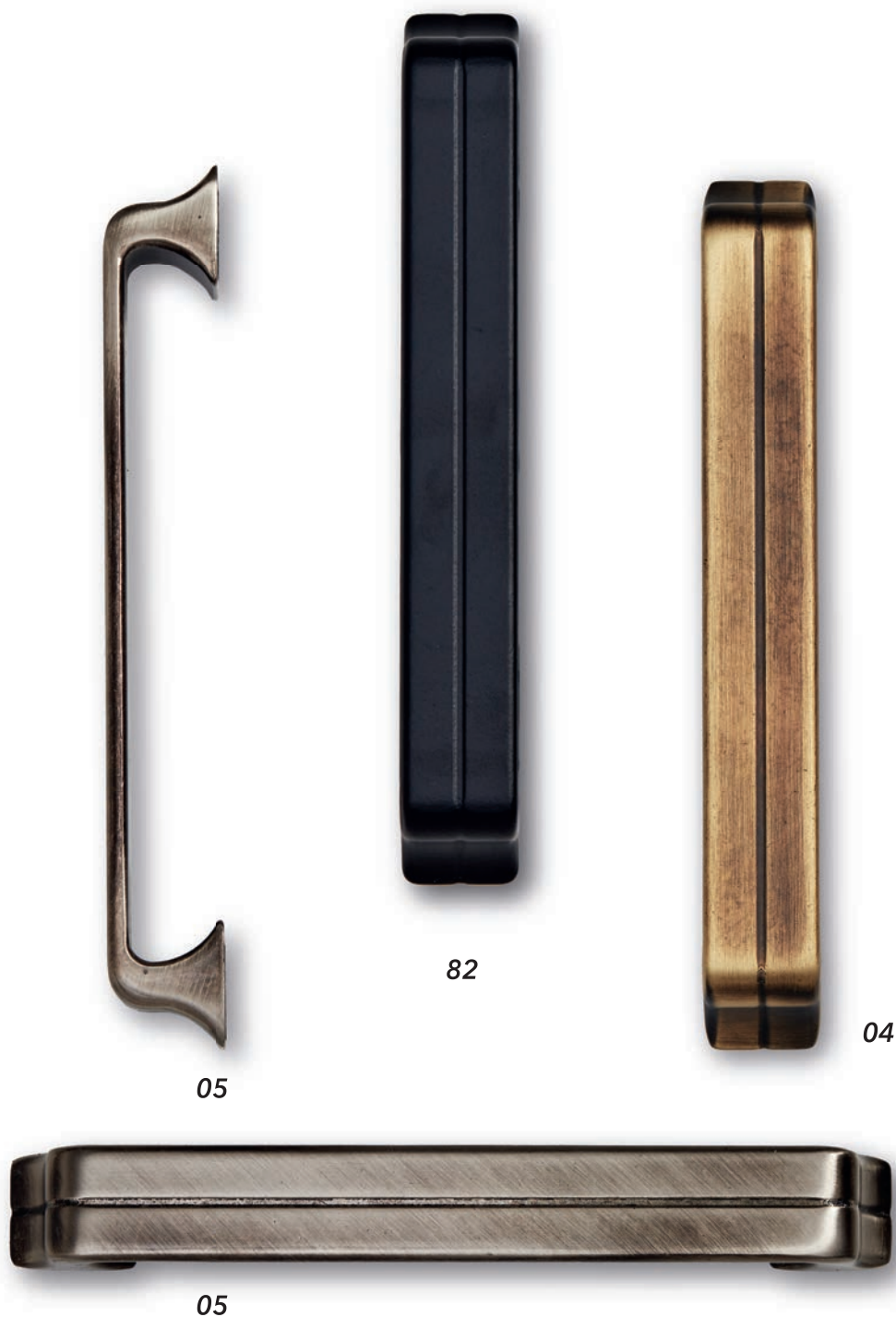

ÁREA TÉCNICA • TECHNICAL AREA • DOMAINE TECHNIQUE • TECHNISCHER BEREICH

Design: Ferramol®

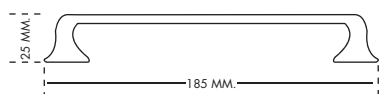

Ref. 2701  
Material: Zamak

FINISHES					
03	04	05	82	L	⊖ ⊖
Cobre viejo Old cooper Vieux cuivre Altes kupfer	Oro viejo Old gold Vieux or Altes gold	Plata vieja Old silver Vieux argent Altes silber	Negro mate Matt black Noir mat Mattes schwarz	Largo Lenght Long Lang	Tornillos Screws Des vis Seiten
2701 160 03	2701 160 04	2701 160 05	2701 160 82	185 MM.	160 MM. 25 pz./box



05



82



03



03

ÁREA TÉCNICA • TECHNICAL AREA • DOMAINE TECHNIQUE • TECHNISCHER BEREICH

Design: Ferramol®

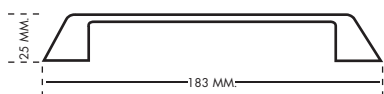

Ref. 2703  
Material: Zamak

FINISHES					
03	04	05	82	L	⊕ ⊖
<i>Cobre viejo</i>	<i>Oro viejo</i>	<i>Plata vieja</i>	<i>Negro mate</i>	<i>Largo</i>	<i>Tornillos</i>
<i>Old cooper</i>	<i>Old gold</i>	<i>Old silver</i>	<i>Matt black</i>	<i>Lenght</i>	<i>Screws</i>
<i>Vieux cuivre</i>	<i>Vieux or</i>	<i>Vieux argent</i>	<i>Noir mat</i>	<i>Long</i>	<i>Des vis</i>
<i>Altes kupfer</i>	<i>Altes gold</i>	<i>Altes silber</i>	<i>Mattes schwarz</i>	<i>Lang</i>	<i>Seiten</i>
2703 160 03	2703 160 04	2703 160 05	2703 160 82	183 MM.	160 MM. 25 pz./box



05



04



03



82



82



ÁREA TÉCNICA • TECHNICAL AREA • DOMAINE TECHNIQUE • TECHNISCHER BEREICH

Design: Ferramol®



Ref. 2735  
Material: Zamak

FINISHES					
03	04	05	82	L	⊕ ⊖
Cobre viejo Old cooper Vieux cuivre Altes kupfer	Oro viejo Old gold Vieux or Altes gold	Plata vieja Old silver Vieux argent Altes silber	Negro mate Matt black Noir mat Mattes schwarz	Largo Lenght Long Lang	Tornillos Screws Des vis Seiten
2735 160 03	2735 160 04	2735 160 05	2735 160 82	203 MM.	160 MM. 25 pz./box



82



05



04



82

ÁREA TÉCNICA • TECHNICAL AREA • DOMAINE TECHNIQUE • TECHNISCHER BEREICH

Design: Ferramol®

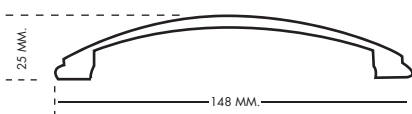

Ref. 2663  
Material: Zamak

FINISHES				
04	05	82	L	⊕ ⊖
Oro viejo Old gold Vieux or Altes gold	Plata vieja Old silver Vieux argent Altes silber	Negro mate Matt black Noir mat Mattes schwarz	Largo Lenght Long Lang	Tornillos Screws Des vis Seiten
2663 04	2663 05	2663 82	148 MM.	128 MM. 50 pz./box





82



04



05



82

ÁREA TÉCNICA • TECHNICAL AREA • DOMAINE TECHNIQUE • TECHNISCHER BEREICH

Design: Ferramol®

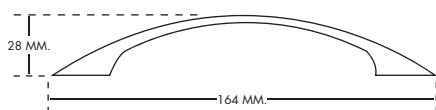

Ref. 3080  
Material: Zamak

FINISHES					
04	05	82	L	⊕ ⊖	
Oro viejo Old gold Vieux or Altes gold	Plata vieja Old silver Vieux argent Altes silber	Negro mate Matt black Noir mat Mattes schwarz	Largo Lenght Long Lang	Tornillos Screws Des vis Seiten	
3080 04	3080 05	3080 82	164 MM.	128 MM.	50 pz./box



04



82



05



82

ÁREA TÉCNICA • TECHNICAL AREA • DOMAINE TECHNIQUE • TECHNISCHER BEREICH

Design: Ferramol®



Ref. 2660  
Material: Zamak

FINISHES					
04	05	82	L	⊕ ⊖	
Oro viejo Old gold Vieux or Altes gold	Plata vieja Old silver Vieux argent Altes silber	Negro mate Matt black Noir mat Mattes schwarz	Largo Lenght Long Lang	Tornillos Screws Des vis Seiten	
2660 04	2660 05	2660 82	155 MM.	128 MM.	50 pz./box





ÁREA TÉCNICA • TECHNICAL AREA • DOMAINE TECHNIQUE • TECHNISCHER BEREICH

Design: Ferramol®

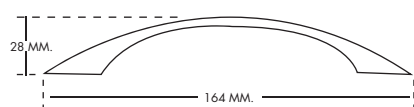

Ref. 3090  
Material: Zamak

FINISHES					
04	05	82	L		
Oro viejo Old gold Vieux or Altes gold	Plata vieja Old silver Vieux argent Altes silber	Negro mate Matt black Noir mat Mattes schwarz	Largo Lenght Long Lang	Tornillos Screws Des vis Seiten	
3090 04	3090 05	3090 82	164 MM.	128 MM.	50 pz./box



03



04



05



82

ÁREA TÉCNICA • TECHNICAL AREA • DOMAINE TECHNIQUE • TECHNISCHER BEREICH

Design: Ferramol®

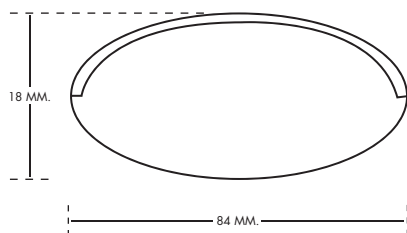

Ref. 2210  
Material: Zamak

FINISHES						
03	04	05	82	L	⊕ ⊖	
Cobre viejo Old cooper Vieux cuivre Altes kupfer	Oro viejo Old gold Vieux or Altes gold	Plata vieja Old silver Vieux argent Altes silber	Negro mate Matt black Noir mat Mattes schwarz	Largo Lenght Long Lang	⊕ ⊖	Tornillos Screws Des vis Seiten
2210 064 03	2210 064 04	2210 064 05	2210 064 82	84 MM.	64 MM.	25 pz./box



82



94



95



82

ÁREA TÉCNICA • TECHNICAL AREA • DOMAINE TECHNIQUE • TECHNISCHER BEREICH

Design: Ferramol®

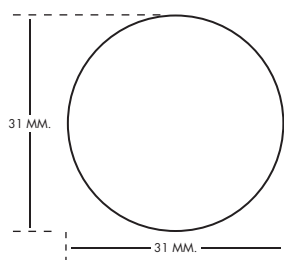

Ref. 2217  
Material: Zamak

FINISHES			
82	94	95	L
Negro mate Matt black Noir mat Mattes schwarz	Oro viejo rústico Rustic old gold Rustic vieux or Rustikales alt-gold	Plata vieja rústica Rustic old silver Rustic vieux arg. Rustikales alt-silv.	Largo Lenght Long Lang
2217 82	2217 94	2217 95	31 MM.



25 pz./box

82



94



95



94



**ÁREA TÉCNICA • TECHNICAL AREA • DOMAINE TECHNIQUE • TECHNISCHER BEREICH**

Design: Ferramol®

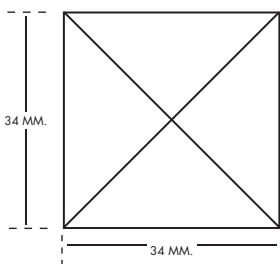

**Ref. 2216**  
Material: Zamak

FINISHES			
82	94	95	L
Negro mate Matt black Noir mat Mattes schwarz	Oro viejo rústico Rustic old gold Rustic vieux or Rustikales alt-gold	Plata vieja rústica Rustic old silver Rustic vieux arg. Rustikales alt-silv.	Largo Lenght Long Lang
2216 82	2216 94	2216 95	34 MM.



25 pz./box





95



82



94

ÁREA TÉCNICA • TECHNICAL AREA • DOMAINE TECHNIQUE • TECHNISCHER BEREICH

Design: Ferramol®

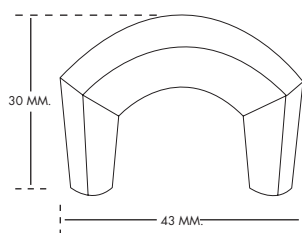

Ref. 2218  
Material: Zamak

FINISHES					
82	94	95	L	 	
Negro mate Matt black Noir mat Mattes schwarz	Oro viejo rústico Rustic old gold Rustic vieux or Rustikales alt-gold	Plata vieja rústica Rustic old silver Rustic vieux arg. Rustikales alt-silv.	Largo Lenght Long Lang	Tornillos Screws Des vis Seiten	
2218 82	2218 94	2218 95	43 MM.	32 MM.	25 pz./box



82



94



95

**ÁREA TÉCNICA • TECHNICAL AREA • DOMAINE TECHNIQUE • TECHNISCHER BEREICH**

Design: Ferramol®

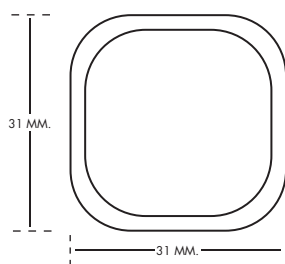

**Ref. 2219**  
Material: Zamak

FINISHES			
82	94	95	L
Negro mate Matt black Noir mat Mattes schwarz	Oro viejo rústico Rustic old gold Rustic vieux or Rustikales alt-gold	Plata vieja rústica Rustic old silver Rustic vieux arg. Rustikales alt-silv.	Largo Lenght Long Lang
2219 82	2219 94	2219 95	31 MM.



25 pz./box



04



05



05



82

ÁREA TÉCNICA • TECHNICAL AREA • DOMAINE TECHNIQUE • TECHNISCHER BEREICH

Design: Ferramol®

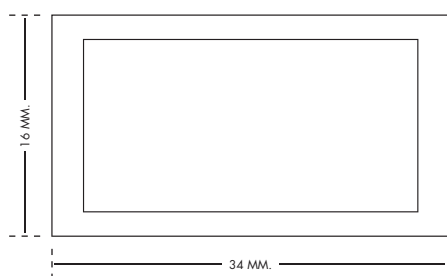

Ref. 2211  
Material: Zamak

FINISHES					
03	04	05	82	L	⊕ ⊖
<i>Cobre viejo</i>	<i>Oro viejo</i>	<i>Plata vieja</i>	<i>Negro mate</i>	<i>Largo</i>	<i>Tornillos</i>
<i>Old cooper</i>	<i>Old gold</i>	<i>Old silver</i>	<i>Matt black</i>	<i>Lenght</i>	<i>Screws</i>
<i>Vieux cuivre</i>	<i>Vieux or</i>	<i>Vieux argent</i>	<i>Noir mat</i>	<i>Long</i>	<i>Des vis</i>
<i>Altes kupfer</i>	<i>Altes gold</i>	<i>Altes silber</i>	<i>Mattes schwarz</i>	<i>Lang</i>	<i>Seiten</i>
2211 03	2211 04	2211 05	2211 82	68 MM.	64 MM.



25 pz./box



**ÁREA TÉCNICA • TECHNICAL AREA • DOMAINE TECHNIQUE • TECHNISCHER BEREICH**

Design: Ferramol®

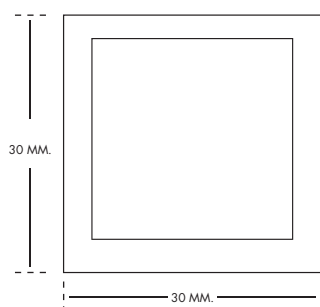

**Ref. 2212**  
Material: Zamak

FINISHES				
03	04	05	82	L
<i>Cobre viejo</i>	<i>Oro viejo</i>	<i>Plata vieja</i>	<i>Negro mate</i>	<i>Largo</i>
<i>Old cooper</i>	<i>Old gold</i>	<i>Old silver</i>	<i>Matt black</i>	<i>Lenght</i>
<i>Vieux cuivre</i>	<i>Vieux or</i>	<i>Vieux argent</i>	<i>Noir mat</i>	<i>Long</i>
<i>Altes kupfer</i>	<i>Altes gold</i>	<i>Altes silber</i>	<i>Mattes schwarz</i>	<i>Lang</i>
2212 03	2212 04	2212 05	2212 82	30 MM.



25 pz./box



**Asturiana de Zinc, S.A.U.**  
SUCESORAS QUINCE

Apartado 178  
33400 - AVILES (Asturias)  
España

**CERTIFICADO DE CALIDAD Y LISTA DE EMBALAJE**  
QUALITY CERTIFICATE AND PACKING LIST  
Certificado de Inspección Tipo 3.1 según EN 10 204 Nº 8.695 / 17

Este documento / This document certifies that the material described herein / certifies that the material described herein conforms to the requirements of the specifications mentioned herein / conforms to the requirements of the specifications mentioned herein.

**DESCRIPCIÓN**

Nº de pedido / Order Nº: 14.890 Material: aluminio / aluminum: AL 9

Producto / Product: 14.294.2 Descripción: HERRAJES / BRACKETS

Nº de entrega / Delivery Nº: 8 Dirección: Zona logística del cliente

Nº de inspección / Inspection Nº: 18 Nº de inspección / Inspection Nº: 1-8711

Nº de entrega / Delivery Nº: 2112 Fecha de emisión / Issue Date: 2017.07

Nombre / Name: CARBON Referencia para usar / Reference to use: R 47M-BAC

**Este acero cumple (EN-80) según el apartado 4.º de:**

Factor	Ten %	Carbon	Pb %	Cu %	Sn %	Fe %	Zn %	Al %	Si %	Mn %	Ni %	P %	As %	S %
14/11/2017	894	108	12	4,5	0,1	0,02	0,002	0,002	0,002	0,002	0,002	0,002	0,002	0,004
14/11/2017	892	108	10	4,5	0,1	0,04	0,002	0,002	0,002	0,002	0,002	0,002	0,002	0,004
14/11/2017	896	108	4	4,5	0,1	0,04	0,002	0,002	0,002	0,002	0,002	0,002	0,002	0,004
14/11/2017	895	108	14	3,8	0,1	0,04	0,002	0,002	0,002	0,002	0,002	0,002	0,002	0,004
14/11/2017	893	108	3	4,5	0,1	0,04	0,002	0,002	0,002	0,002	0,002	0,002	0,002	0,004
14/11/2017	892	105	12	5,2	0,1	0,02	0,002	0,002	0,002	0,002	0,002	0,002	0,002	0,004
14/11/2017	891	106	3	4,5	0,1	0,04	0,002	0,002	0,002	0,002	0,002	0,002	0,002	0,004
14/11/2017	894	108	6	4,5	0,1	0,04	0,002	0,002	0,002	0,002	0,002	0,002	0,002	0,004
14/11/2017	896	108	6	4,5	0,1	0,04	0,002	0,002	0,002	0,002	0,002	0,002	0,002	0,004
14/11/2017	892	105	6	4,5	0,1	0,04	0,002	0,002	0,002	0,002	0,002	0,002	0,002	0,004
14/11/2017	895	106	10	4,5	0,1	0,04	0,002	0,002	0,002	0,002	0,002	0,002	0,002	0,004
14/11/2017	896	108	11	4,5	0,1	0,04	0,002	0,002	0,002	0,002	0,002	0,002	0,002	0,004
14/11/2017	895	106	4	3,8	0,1	0,04	0,002	0,002	0,002	0,002	0,002	0,002	0,002	0,004
14/11/2017	894	108	10	4,5	0,1	0,04	0,002	0,002	0,002	0,002	0,002	0,002	0,002	0,004

San Juan de Nueva, 28 de Noviembre de 2017

RESPONSABLE

**Authorization to use the quality sign**

ALUMINIUM ASSOCIATION  
EUROPEAN ASSOCIATION  
ANODIZING QUALANO

This is to certify that  
**HERRAJES FERRAMOL, S.L.U.**  
C/Albat, 71  
46687 - Albalat de la Ribera - Valencia - España

License number: 1039

It is authorized to use the quality sign which is shown above, according to the regulations for the use of the quality label for ARCHITECTURAL ANODIZING as described in the current edition of the Specifications for the QUALANO quality label for sulfate acid-based anodizing of aluminum (Edition 01.07.2010).

Date of issue of the license: 21.07.2006  
Period of validity of the license: until 21.12.2017

Zurich, 15 November 2016

QUALANO  
Josef Amann  
President

CERTIFICATION BODY  
Josef Schwegg  
AC-Fabrikare SA

Postal address:  
QUALANO, P.O. Box 1987, CH-8027 Zurich  
Domicile:  
QUALANO on AC-Fabrikare SA, Taldenstrasse 47, CH-8027 Zurich

Phone:  
+41 (0)43 355 00 70  
+41 (0)43 355 09 98  
E-mail:  
info@qualano.net  
www.qualano.net

**FERRAMOL**

Company (customer/part): 0910900 RAL 9005

Application: Interior

Surface finish: Smooth

Gloss: Mat 20 ±1.5

Recommended film thickness: 60 - 80 [µm] max. to ISO 2980

Cure parameters: 200 [C] / 10 [min] | 190 [C] / 12 [min]

Application: Corona T100

Storage stability: 6 months at no more than 25 °C

Safety data sheet: TIGER DRYER™ powder coatings are made for industrial applications and should be applied according to guidelines as set forth in our product and safety data sheets which are made available upon inquiry.

Please note: Material effects, application and relevant product data sheet and additionally, to guidelines of application (such as heat-treated surface)

**TEST RESULTS**  
Checked on a thermal aluminum test panel which is 0.7 mm thick. Cure conditions according to the cure schedule.

TEST	TEST STANDARD	TEST RESULTS
Cross cut test 1 mm	ISO 2409	GT 0
Cupping test	ISO 1552	3 [mm]
Mandrel bending test	ISO 1518	+10 [mm]
Impact test (20 inch-pound)	ASTM D 2794	Minor cracks
Salt spray resistance 960 hrs.	ISO 9227	Max. undercoating 1 [mm]
Stability resistance 800 hrs.	ISO 8470	Max. blanching 1 [mm]

17.05.13 The Product Specification Sheet has been produced electronically Page 20 of 11

Our initial and further recommendations for the use of our products are based upon experience and in accordance with present technological standards. These are given in order to support the buyer or user. They are non-committal and do not create any additional obligations to the process agreement. They do not make us liable for any damage to the material or products for the intended application. We warrant that our products are free of flaws and defects to the extent as stipulated in our Terms of Delivery and Payment. As a part of our product information program each of our Product Data Sheets and technical drawings is accompanied by a copy of our product information program. We shall be pleased to provide this program. Therefore, please contact our sales department to make sure that the Product Data Sheet is the most current version. The information in our Product Data Sheets is subject to change without notification, enquiry and the Terms of Delivery and Payment, each in their latest version, available at [www.ferramol.com](http://www.ferramol.com) in the electronic area. Form an integral part of this Product Specification Sheet.

**CERTIFICADO DE CALIDAD (Pág. 1)**

**EXTRUAL**

HERRAJES FERRAMOL, S.L.U.  
C/Albat, 71  
46687 ALBALAT DE LA RIBERA - VALNCIA

At: Don Carlos

El responsable Don Carlos, en nombre de la Mercantil EXTRUDOS DEL ALUMINIO S.A., con domicilio social en Albalat, Polígono Industrial Compulans, Calle A, parcela nº 24,

**CERTIFICA**  
Que el material entregado a HERRAJES FERRAMOL, S.L.U. contenido en el albarán 17EX-09682 de fecha 11/09/17 fue fabricado utilizando las siguientes especificaciones y procesos:

\* Aluminio base para la extrusión:  
Perfil 12206 Tipo: EFL ALICACION 6063/6060, estado 48127 de ALCOA INESPAL, S.A. de composición:

Fe	Cu	Mn	Si	Zn	Ti	Mg	Al
0,18	0,010	0,008	0,45	0,0010	0,018	0,42	98,89

(Este dato sea suministrado por nuestro proveedor)

\* Tratamiento térmico de endurecimiento:  
Estado: T5

Control, dur. exp. mín.	Dureza real
Webster	Brinell
10	80
	10

Segun Norma UNE EN 755-1 Y UNE EN 12020-1

\* Dimensiones y tolerancias:  
Segun plano y UNE EN 755-2 Y UNE EN 12020-2

\* Tratamiento superficial por anodizado:  
El perfil indicado ha recibido el acabado 505, que corresponde a un Anod. (10 Minutos) y ha sido sometido a los ensayos que establece las Directivas de QUALANO según EN 603210.

ENSAYO	NORMA	CARACTERÍSTICAS
Espejor	ISO 2380	± 40 micras en caras vistas
Afinamiento	ISO 2400	0
Tal de extrusión	ISO 1025	± 0,3 mm
Resistencia a la tracción	ISO 1518	50 N/mm <sup>2</sup>
Curvas de flexión	ISO 1515	14 mm
Medida salina activa	ISO 8077	± 1000 horas
Tal de perforación	QUALCOAT	3
Resistencia agua hervida	QUALCOAT	Sin desprendimientos
Marcha de 48 horas	QUALCOAT	Comienza < 12 mm de la boquilla
Bolbo (Secado)	ISO 2813	71 - 100 = 10 puntajes
Bolbo (Secado moderado)	ISO 2813	0 - 30 = 4 puntajes
Impacto (pendra de 10,3 mm)	ISO 6272	Sin desprendimientos

Y para que conste a los efectos que proceden, y a petición del interesado, se expide el presente certificado, en Albalat, a 28 de Octubre de 2017.

**CERTIFICADO DE CALIDAD (Pág. 1)**

**EXTRUAL**

HERRAJES FERRAMOL, S.L.U.  
C/Albat, 71  
46687 ALBALAT DE LA RIBERA - VALNCIA

At: Don Carlos

El responsable Don Carlos, en nombre de la Mercantil EXTRUDOS DEL ALUMINIO S.A., con domicilio social en Albalat, Polígono Industrial Compulans, Calle A, parcela nº 24,

**CERTIFICA**  
Que el material entregado a HERRAJES FERRAMOL, S.L.U. contenido en el albarán 17EX-09648 de fecha 11/09/17 fue fabricado utilizando las siguientes especificaciones y procesos:

\* Aluminio base para la extrusión:  
Perfil 12206 Tipo: EFL ALICACION 6063/6060, estado 48127 de ALCOA INESPAL, S.A. de composición:

Fe	Cu	Mn	Si	Zn	Ti	Mg	Al
0,18	0,010	0,008	0,45	0,0010	0,018	0,42	98,89

(Este dato sea suministrado por nuestro proveedor)

\* Tratamiento térmico de endurecimiento:  
Estado: T5

Control, dur. exp. mín.	Dureza real
Webster	Brinell
10	80
	10

Segun Norma UNE EN 755-1 Y UNE EN 12020-1

\* Dimensiones y tolerancias:  
Segun plano y UNE EN 755-2 Y UNE EN 12020-2

\* Tratamiento superficial por anodizado:  
El perfil indicado ha recibido el acabado 505, que corresponde a un Anod. (10 Minutos) y ha sido sometido a los ensayos que establece las Directivas de QUALANO según EN 603210.

ENSAYO	NORMA	CARACTERÍSTICAS
Espejor	UNE-EN-ISO 2380	± 40 - 105 (En 10-25 micras)
Perfil de peso	UNE-EN-1237-7	± 0,3 mm
Espejor de la parte de colorante	UNE-EN-1237-4	0 - 2

Y para que conste a los efectos que proceden, y a petición del interesado, se expide el presente certificado, en Albalat, a 28 de Octubre de 2017.

© FERRAMOL, S.L.

Reservados todos los derechos.

No se permite la reproducción, total o parcial, de ninguna parte de este catálogo y publicación en internet o sobre cualquier otro medio sin la autorización escrita de FERRAMOL®, S.L.

Todos los productos, marcas comerciales y las fotografías reproducidas en este catálogo están sujetos a todas las leyes de propiedad intelectual existentes. Los colores de este catálogo deben ser considerados orientativos.

2024 IMPRESO EN CE

All rights reserved.

Reproduction of any part of this catalogue and publication on the internet or on any other medium is not permitted without FERRAMOL®, S.L. written permission.

All products, trade-marks and photographs reproduced in this catalogue are subject to all existing intellectual property laws.

The colors of this catalogue should be considered merely illustrative.

2024 PRINTED IN CE

Tous droits réservés.

Aucune partie de ce catalogue ne peut être reproduite, en totalité ou en partie, et publiée sur Internet ou sur tout autre support. sans l'autorisation écrite de FERRAMOL®, S.L.

Tous les produits, marques commerciales et photographies reproduits dans ce catalogue soumis à toutes les lois existantes sur la propriété intellectuelle.

Les couleurs figurant dans ce catalogue doivent être considérées comme un guide.

2024 IMPRIMÉ EN CE

**FERRAMOL**®  
SINCE 1979

# FERRAMOL

SINCE 1979

C/ CABAÑAL, 71  
46687 ALBALAT DE LA RIBERA (VALENCIA • SPAIN)

TEL. + 34 962 490 388

 +34 664 377 997

info@ferramol.com  
export@ferramol.com

www.ferramol.com

